



CURTIS

Manual

Model **1244**

MultiMode™ Electronic Motor Controller



Curtis Instruments, Inc.
200 Kisco Avenue
Mt. Kisco, NY 10549
www.curtisinstruments.com



Read Instructions Carefully!

Specifications are subject to change without notice.

© 2013 Curtis Instruments, Inc. ® Curtis is a registered trademark of Curtis Instruments, Inc.

© The design and appearance of the products depicted herein are the copyright of Curtis Instruments, Inc.

16958 Rev E 10/2013

The Curtis Difference 
You feel it when you drive it

CONTENTS

1. OVERVIEW	1
2. INSTALLATION AND WIRING	4
Mounting the Controller	4
Connections: Low Current	6
Connections: High Current	7
Wiring: Controller	8
Wiring: Throttle.....	10
5k Ω -0, 2-wire resistive throttle (“Type 1”)	11
0-5V, current source, 3-wire pot, and electronic single-ended throttles (“Type 2”)	12
0-5k Ω , 2-wire resistive throttle (“Type 3”)	15
0-5V and 3-wire pot wigwag-style throttles (“Type 4”).....	15
CAN-Nodes throttle (“Type 5”)	16
Wiring: Fault Outputs	16
Wiring: Contactor Drivers	16
Wiring: Pedal Switch	19
Wiring: Hour Meter	19
Wiring: CAN Bus Interface	19
Wiring: Emergency Reverse	19
Contactor, Switches, and Other Hardware	21
3. PROGRAMMABLE PARAMETERS	23
Acceleration Parameters	26
Acceleration Rate, M1-M4.....	26
Braking Rate, M1-M4	26
Deceleration Rate	26
Quick Start.....	26
Taper Rate	27
Speed Parameters	27
Maximum Speed, M1-M4	27
Creep Speed, M1-M4	27
Regen Speed	27
Throttle Parameters.....	28
Control Mode.....	28
Throttle Type	29
Throttle Deadband	30
Throttle Max	32
Throttle Map, M1-M4.....	34
Throttle Braking Percent, M1-M4.....	36
Current Limit Parameters	36
Drive Current Limit, M1-M4.....	36
Braking Current Limit, M1-M4.....	36
Minimum Field Current Limit	36
Maximum Field Current Limit	37
Restraint	37
Emergency Reverse Current Limit	38
Current Ratio	38

Field Control Parameters	38
Field Map Start.....	38
Field Map.....	39
Fault Parameters.....	41
High Pedal Disable (HPD)	41
HPD Threshold.....	42
Static Return to Off (SRO).....	42
Fault Code.....	42
Output Driver Parameters.....	43
Main Contactor Driver Interlock.....	43
Main Contactor Dropout Delay	43
Main Coil Open Check.....	44
Main Contactor Weld Check.....	44
Auxiliary Driver Dropout Delay	44
Auxiliary Coil Open Check	44
Reverse Signal Open Check.....	45
Electromagnetic Brake Delay	45
Electromagnetic Brake Open Check	45
Contactor Holding Voltage.....	46
Contactor Pull-in Voltage	46
Other Parameters	46
Battery Voltage	46
Anti-Tiedown	47
Sequencing Delay	47
Pedal Interlock.....	47
Emergency Reverse Enable.....	48
Emergency Reverse Check.....	48
Node Address	48
Precharge	49
Load Compensation	49
4. OEM-SPECIFIED, FACTORY-SET PARAMETERS.....	50
MultiMode™ Enable	50
Accessory Driver Enable.....	50
CAN Bus Enable	51
5. INSTALLATION CHECKOUT	52
6. VEHICLE PERFORMANCE ADJUSTMENT	54
Major Tuning.....	54
Tuning the active throttle range	54
Tuning the controller to the motor	57
Setting the unloaded vehicle top speed	59
Equalizing loaded and unloaded vehicle speed	60
Fine Tuning	62
Response to increased throttle.....	62
Response to reduced throttle.....	63
Smoothness of direction transitions	63
Ramp climbing	65
Ramp restraint	66

7. PROGRAMMER MENUS	67	=====
Parameters Menu	67	=====
Monitor Menu.....	70	=====
Diagnostics Menu.....	71	=====
Other Menus	71	=====
8. DIAGNOSTICS AND TROUBLESHOOTING.....	72	=====
Programmer Diagnostics.....	72	=====
LED Diagnostics	74	=====
Fault Output Drivers	75	=====
9. MAINTENANCE	76	=====
Cleaning	76	=====
Diagnostic History	76	=====
APPENDIX A Glossary of Features and Functions		=====
APPENDIX B Programming Devices		=====
APPENDIX C Specifications, 1244 Controller		=====

FIGURES

FIG. 1: Curtis 1244 electronic motor controller	1
FIG. 2: Mounting dimensions, Curtis 1244 controller	4
FIG. 3: Standard wiring configuration	8
FIG. 4: Wiring for 5kΩ–0 throttle (“Type 1”)	11
FIG. 5: Wiring for wigwag throttle, using the 5kΩ–0 throttle input (“Type 1”)	11
FIG. 6: Wiring for 0–5V throttle (“Type 2”)	12
FIG. 7: Wiring for 3-wire potentiometer throttle (“Type 2”)	13
FIG. 8: Wiring for current source throttle (“Type 2”)	13
FIG. 9: Wiring for Curtis ET-XXX electronic throttle (“Type 2”)	14
FIG. 10: Wiring for 0–5kΩ throttle (“Type 3”)	15
FIG. 11: Wiring for fault outputs	16
FIG. 12: Wiring for main and auxiliary contactor coils when using the interlock and dropout delay features	18
FIG. 13: Wiring for emergency reverse (applicable to walkie vehicles only)	20
FIG. 14: Effect of adjusting the neutral deadband parameter	30, 31
FIG. 15: Effect of adjusting the throttle max parameter	32, 33
FIG. 16: Throttle maps for controller with maximum speed set at 100% and creep speed set at 0	34
FIG. 17: Throttle maps for controller with maximum speed set at 80% and creep speed set at 10%	35
FIG. 18: Influence of various parameters on controller output response to throttle demand	35
FIG. 19: Field current relative to armature current, with field map parameter set at 50% and 20%	40

TABLES

TABLE 1: Voltages at throttle wiper input	10
TABLE 2: Mode selection	22
TABLE 3: Programmable throttle types	29
TABLE 4: Fault categories	43
TABLE 5: Troubleshooting chart	73
TABLE 6: Status LED fault codes	74
TABLE 7: Fault category codes	75
TABLE C-1: Specifications, 1244 controller	C-1

1

OVERVIEW

Curtis 1244 MultiMode™ controllers are separately excited motor speed controllers designed for use in a variety of material handling vehicles. These programmable controllers are simple to install, efficient, and cost effective. Typical applications include low lifts, stackers, fork lifts, reach trucks, personnel carriers, counterbalance trucks, order pickers, boom trucks, and other industrial vehicles.

Fig. 1 *Curtis 1244 MultiMode™ electronic motor controller.*



The 1244 MultiMode™ controller offers smooth, silent, cost effective control of motor speed and torque. A four quadrant, full-bridge field winding control stage is combined with a two quadrant, half-bridge armature power stage to provide solid state motor reversing and regenerative braking power without additional relays or contactors. The 1244 controller can also be specified to be compatible with CAN Bus communication systems.

These controllers are fully programmable by means of the optional hand-held programmer or PC programming station. Use of the programmer provides diagnostic and test capability as well as configuration flexibility.

Like all Curtis motor controllers, the 1244 offers superior operator control of the vehicle's motor drive speed. **Features include:**

- ✓ Full-bridge field and half-bridge armature power MOSFET design, providing
 - infinitely variable forward, reverse, drive, and brake control
 - silent high frequency operation
 - high efficiency
- ✓ Regenerative braking, providing longer operation on a single battery charge and reducing motor brush wear and motor heating
- ✓ Programmability through the 1313 handheld programmer and 1314 PC Programming Station
- ✓ Complete diagnostics through the programmer and the internal Status LED
- ✓ Two fault outputs provide diagnostics to remotely mounted displays
- ✓ Continuous armature current control, reducing arcing and brush wear
- ✓ Automatic braking when throttle is reduced from either direction; this provides a compression braking feel and enhances safety by automatically initiating braking in an operator hands off condition
- ✓ Deceleration Rate, Load Compensation, and Restraint features prevent downhill runaway conditions; speed is controlled to within approximately 20% of level surface value
- ✓ MultiMode™ allows four user-selectable vehicle operating personalities
- ✓ Programmable to match individual separately excited motor characteristics
- ✓ Meets or exceeds EEC fault detect requirements
- ✓ Vehicle top speed is controlled and limited in each mode
- ✓ Linear temperature and undervoltage cutback on motor currents; no sudden loss of power under any thermal conditions
- ✓ High pedal disable (HPD) and static return to off (SRO) interlocks prevent vehicle runaway at startup
- ✓ Creep speed adjustable from 0% to 25% in each mode
- ✓ Continuous diagnostics during operation, with microprocessor power-on self-test
- ✓ Internal and external watchdog circuits ensure proper software operation
- ✓ Programmable coil drivers provide adjustable contactor pull-in and holding voltages
- ✓ Hour-meter enable output is active whenever the controller is providing motor current
- ✓ Optional Electromagnetic Brake Driver provides automatic control of an electromagnetic brake or other similar function
- ✓ Optional Reverse Signal Driver provides a low signal any time the vehicle is driving or braking in reverse

- ✓ Optional Auxiliary Driver provides a low signal to power an auxiliary contactor or other similar function
- ✓ Driver outputs are short circuit protected and provide built-in coil spike protection
- ✓ Controller is programmable to provide throttle control of motor speed, applied motor voltage, or motor torque
- ✓ Can be configured for CAN Bus compatibility.

Familiarity with your Curtis controller will help you install and operate it properly. We encourage you to read this manual carefully. If you have questions, please contact the Curtis office nearest you.

2

INSTALLATION AND WIRING

MOUNTING THE CONTROLLER

The outline and mounting hole dimensions for the 1244 controller are shown in Figure 2.

The controller can be oriented in any position, and meets the IP64/IP67 ratings for environmental protection against dust and water. However, **the location should be carefully chosen to keep the controller as clean and dry as possible.** When selecting the mounting position, be sure to also take into consideration (1) that access is needed at the top of the controller to plug the

Fig. 2 Mounting dimensions, Curtis 1244 controller.

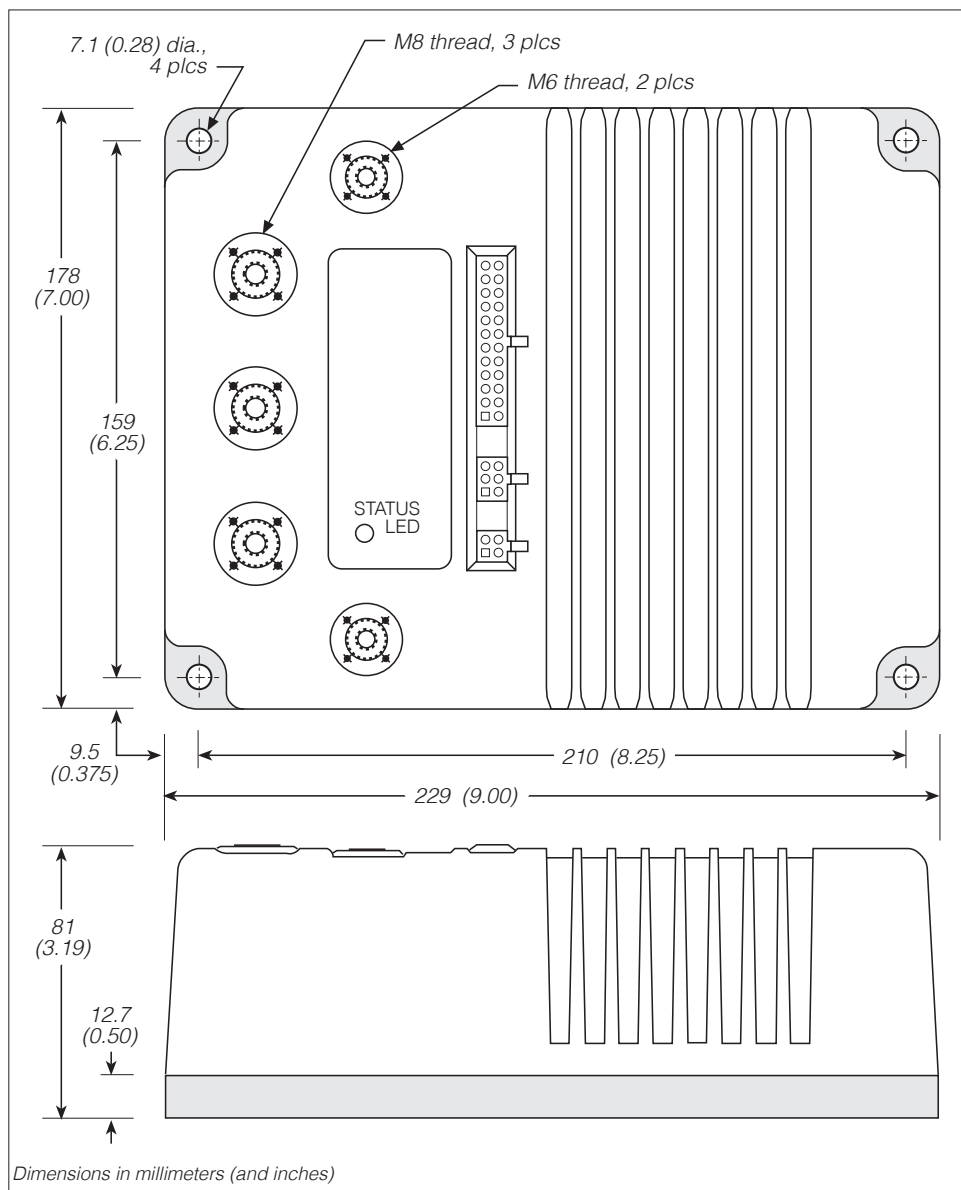

programmer into its connector, and (2) that the built-in Status LED is visible only through the view port in the label on top of the controller.

To ensure full rated power, the controller should be fastened to a clean, flat metal surface with four 6 mm (1/4") diameter screws, using the holes provided. Although not usually necessary, a thermal joint compound can be used to improve heat conduction from the controller heatsink to the mounting surface.



Working on electric vehicles is potentially dangerous. You should protect yourself against runaways, high current arcs, and outgassing from lead acid batteries:

RUNAWAYS — Some conditions could cause the vehicle to run out of control. Disconnect the motor or jack up the vehicle and get the drive wheels off the ground before attempting any work on the motor control circuitry.

NOTE: If the wrong throttle type is selected with the programming device, the vehicle may suddenly begin to move.

HIGH CURRENT ARCS — Electric vehicle batteries can supply very high power, and arcs can occur if they are short circuited. Always open the battery circuit before working on the motor control circuit. Wear safety glasses, and use properly insulated tools to prevent shorts.

LEAD ACID BATTERIES — Charging or discharging generates hydrogen gas, which can build up in and around the batteries. Follow the battery manufacturer's safety recommendations. Wear safety glasses.

CONNECTIONS

Low Current Connections

Three low current connectors are built into the 1244 controller. They are located in a row on the top of the controller:

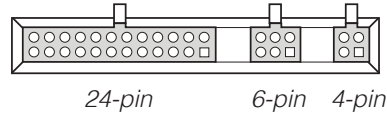

The 24-pin connector provides the logic control connections. The mating connector is a 24-pin Molex Mini-Fit Jr. connector part number 39-01-2245 using type 5556 terminals.

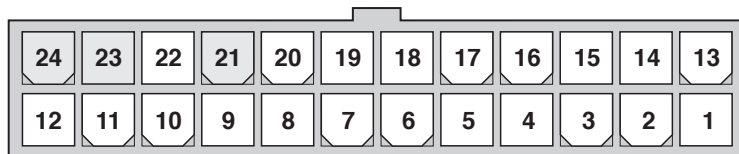

Pin 1	keyswitch input (KSI)
Pin 2	interlock input
Pin 3	Mode Select 1 input
Pin 4	Mode Select 2 input
Pin 5	Fault 1 output
Pin 6	Fault 2 output
Pin 7	emergency reverse input
Pin 8	pedal switch input
Pin 9	coil return input
Pin 10	forward input
Pin 11	reverse input
Pin 12	hour meter enable output
Pin 13	throttle: 3-wire pot high
Pin 14	throttle: pot low
Pin 15	throttle: 3-wire pot wiper or 0–5V
Pin 16	throttle: 2-wire 5kΩ–0 or 0–5kΩ input
Pin 17	main contactor driver output
Pin 18	auxiliary contactor driver output
Pin 19	reverse signal driver output
Pin 20	electromagnetic brake driver output
Pin 21	(not used)
Pin 22	emergency reverse check output
Pin 23	(not used)
Pin 24	(not used)

A 6-pin low power Molex connector is provided for the CAN Bus interface. However, the CAN Bus option must be specified for this interface to be active. The mating connector is a Molex Mini-Fit Jr. p/n 39-01-2065 using type 5556 terminals.



Pin 1	+15V supply (limited)
Pin 2	ground return (B-)
Pin 3	CAN H I/O line
Pin 4	L termination
Pin 5	H termination
Pin 6	CAN L I/O line

The +15V supply should only be used with the CAN system or speed sensor and not to power any other external systems.

The L and H terminations provide a 120Ω termination impedance for the CAN H I/O and CAN L I/O inputs if necessary. Refer to the Curtis CAN Protocol Document to determine the proper termination for a given application.

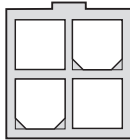

A 4-pin low power connector is provided for the handheld 1313 programmer or 1314 PC programming station. A complete programmer kit, including the appropriate connecting cable, can be ordered from Curtis.

If a programmer is already available but has an incompatible cable, the 1244 mating cable can be ordered as a separate part: Curtis p/n 16185.

High Current Connections

Five tin-plated solid aluminum bus bars are provided for the high current connections to the battery (B+ and B-), the motor armature (M-), and the motor field (F1 and F2). These bus bars incorporate threaded mounting studs designed to accept mounting bolts. The B+, B-, and M- bus bars are threaded to accept M8 bolts to a depth of 3/4". The F1 and F2 bus bars are threaded to accept M6 bolts to a depth of 5/8". This simplifies the assembly and reduces the mounting hardware necessary for the power connections. The tightening torque applied to the bolts should not exceed 16.3 N·m (12 ft-lbs) for the M6 bolts or 20 N·m (15 ft-lbs) for the M8 bolts. Exceeding these specifications could damage the bus bars' internal threads, resulting in loose connections.

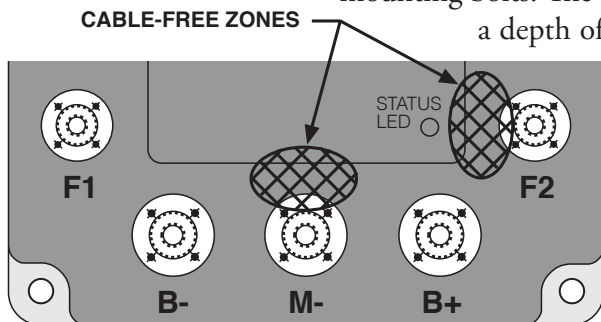

Power cables must not be routed over the indicated areas. Otherwise they may interfere with the proper operation of sensitive electromagnetic components located underneath.

WIRING: Standard Configuration

Figure 3 shows the typical wiring configuration for most applications. The interlock switch is typically a seat switch, tiller switch, or foot switch.

Standard Power Wiring

Motor armature winding is straightforward, with the armature's A1 connection going to the controller's B+ bus bar and the armature's A2 connection going to the controller's M- bus bar.

The motor's field connections (F1 and F2) to the controller are less obvious. The direction of vehicle travel with the forward direction selected will depend on how the F1 and F2 connections are made to the controller's two field terminals and how the motor shaft is connected to the drive wheels through the vehicle's drive train.

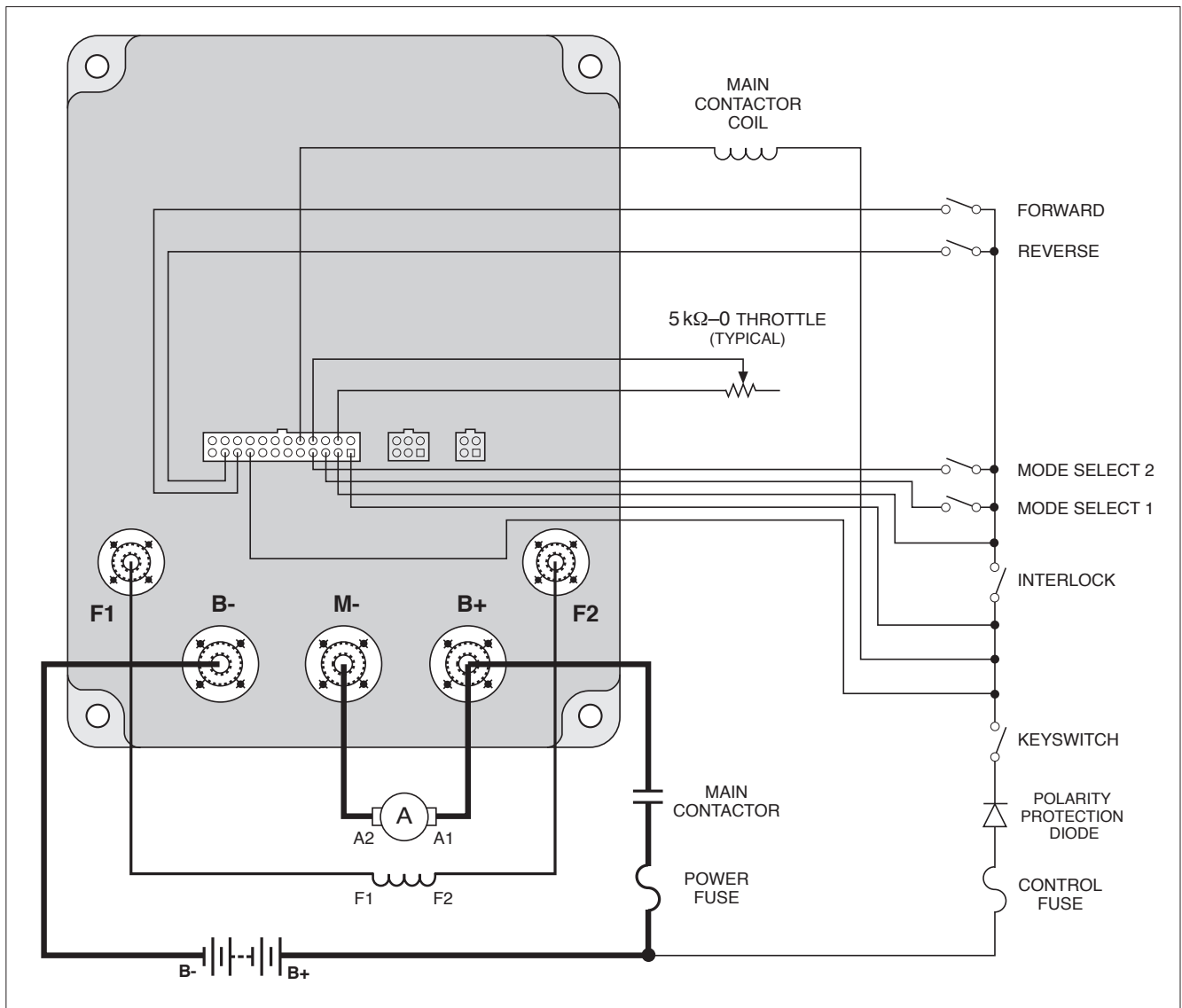
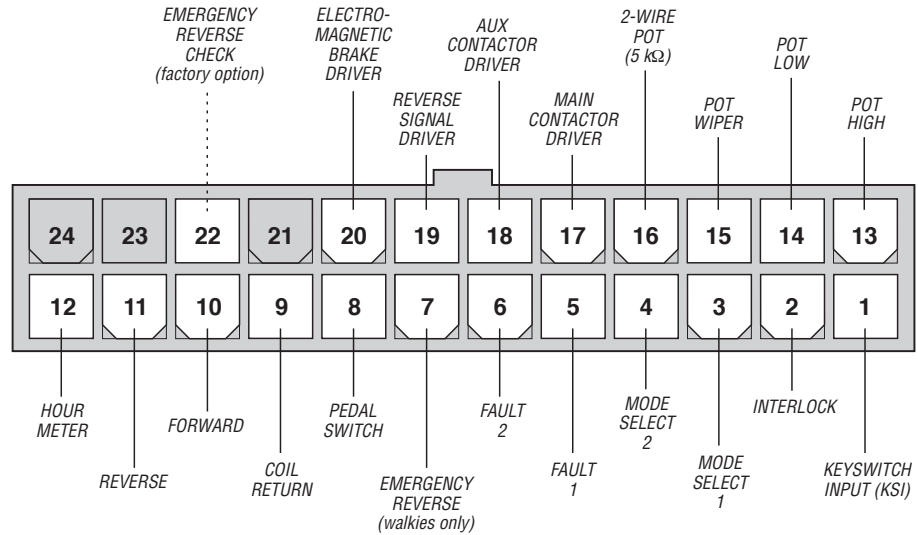

Fig. 3 Standard wiring configuration, Curtis 1244 controller.

Standard Control Wiring

Wiring for the input switches and contactors is shown in Figure 3; the connector is shown in more detail below.

24-pin detail (see Fig. 3):



The main contactor coil must be wired directly to the controller as shown in Figure 3. The controller can be programmed to check for welded or missing main contactor faults and uses the main contactor coil driver output to remove power from the controller and motor in the event of various other faults. **If the main contactor coil is not wired to Pin 17, the controller will not be able to open the main contactor in serious fault conditions and the system will therefore not meet EEC safety requirements.**

WIRING: Throttle

Various throttles can be used with the 1244 controller. They are categorized as one of five types in the programming menu of the handheld programmer.

Type 1: two-wire 5k Ω –0 throttles

Type 2: 0–5V throttles, current source throttles, three-wire potentiometer throttles, and electronic throttles—wired for single-ended operation

Type 3: two-wire 0–5k Ω throttles

Type 4: 0–5V and three-wire potentiometer throttles—wired for wig-wag-style operation

Type 5: CAN-Nodes throttles

The operating specifications for these throttle types are summarized in Table 1.

Table 1 THROTTLE WIPER INPUT: THRESHOLD VALUES

THROTTLE TYPE	PARAMETER	MINIMUM THROTTLE FAULT	THROTTLE DEADBAND (0% throttle)	HPD (25% throttle active range)	THROTTLE MAX (100% modulation)	MAXIMUM THROTTLE FAULT
1	Wiper Voltage	0.1 V	3.3 V	1.0 V	0.2 V	4.4 V
	Wiper Resistance	—	5.0 k Ω	3.8 k Ω	0 k Ω	7.5 k Ω
2	Wiper Voltage	(none)	0.2 V	1.4 V	5.0 V	5.5 V
	Wiper Resistance	—	—	—	—	—
3	Wiper Voltage	0.1 V	0.2 V	1.0 V	3.3 V	4.4 V
	Wiper Resistance	—	0 k Ω	1.3 k Ω	5.0 k Ω	7.5 k Ω
4	Wiper Voltage	0.5 V	2.5 V (fwd)*	3.1 V (fwd)	4.4 V (fwd)	4.5 V
			2.5 V (rev)*	1.9 V (rev)	0.6 V (rev)	
	Wiper Resistance		2.5 k Ω (fwd)*	3.1 k Ω (fwd)	4.4 k Ω (fwd)	
			2.5 k Ω (rev)*	1.9 k Ω (rev)	0.6 k Ω (rev)	
5	Wiper Voltage	N/A	N/A	N/A	N/A	N/A
	Wiper Resistance	N/A	N/A	N/A	N/A	N/A

Notes: The Upper and Lower Deadbands are valid for nominal 5k Ω potentiometers or 5V sources with the default Throttle Deadband and Throttle Max parameter settings of 0% and 100% respectively. These values will change with variations in the Throttle Deadband and Throttle Max parameter settings—see *Section 3, pages 30 and 32*.

The HPD threshold is a percentage of the active throttle range, which is dependent on the programmed Throttle Deadband and Throttle Max settings. The default HPD Threshold is 25%; the programmable range is 0–25%.

* With 0% Throttle Deadband, there is no neutral point on a Type 4 throttle. It is recommended that an 8% minimum deadband be used with Type 4 throttles.

All throttle fault protection is accomplished by monitoring the wiper input. This provides throttle fault protection that meets all EEC requirements. Thus, no additional fault protection is required on any throttle type used with the 1244 controller.

Wiring for various throttles is described below. NOTE: In the text, throttles are identified by their nominal range and not by their actual operating range.

If the throttle you are planning to use is not covered, contact the Curtis office nearest you.

5k Ω -0 Throttle (“Type 1”)

The 5k Ω -0 throttle (called a “Type 1” throttle in the programming menu of the handheld programmer) is a 2-wire resistive throttle that connects between the 2-Wire Pot and Pot Low pins (Pins 16 and 14), as shown in Figure 4. It doesn't matter which wire goes on which pin. For Type 1 throttles, zero speed corresponds to a nominal 5 k Ω measured between the two pins and full speed corresponds to 0 Ω . (NOTE: This wiring is also shown in the standard wiring diagram, Figure 3.)

Fig. 4 Wiring for 5k Ω -0 throttle (“Type 1”).

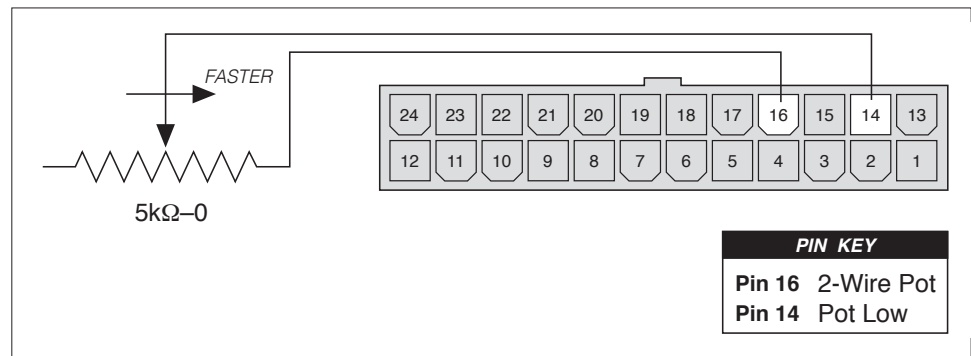

In addition to accommodating the basic 5k Ω -0 throttle, the Type 1 throttle can also be used to implement a wigwag-style throttle. Using a 20k Ω pot wired as shown in Figure 5, the pot wiper can be set such that the controller has 5 k Ω between Pins 16 and 14 when the throttle is in the neutral position. The throttle mechanism can then be designed such that rotating it either forward or back decreases the resistance between Pins 16 and 14, which increases the controller output. The throttle mechanism must provide signals to the controller's forward and reverse inputs independent of the throttle pot resistance. The controller will not sense direction from the pot resistance with Throttle Type 1. For true

Fig. 5 Wiring for 20k Ω potentiometer used as part of a wigwag-style throttle (“Type 1”).

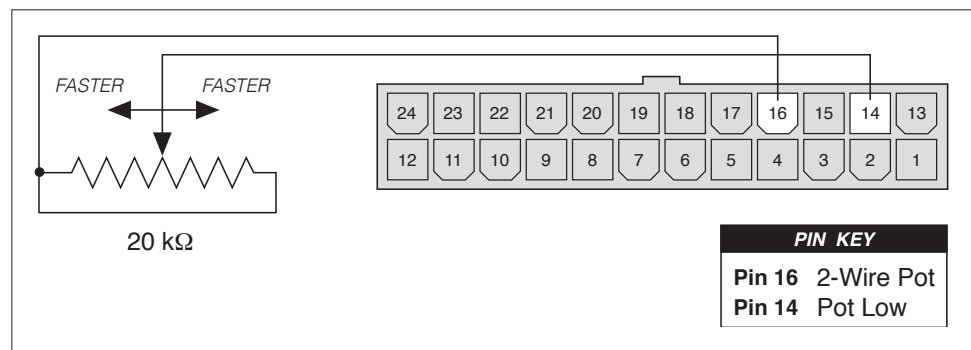

wigwag-style control—without the necessity of providing independent forward and reverse input signals—see Throttle Type 4.

If the total resistance between Pins 14 and 16 is greater than 7.5 k Ω , the controller's 4.4 V upper fault limit will be exceeded and the controller output will be disabled. This provides broken wire protection, and also serves as an indication that the potentiometer's nominal value has increased and the pot needs to be replaced.

0–5V, 3-Wire Potentiometer, Current Source, and Electronic Single-Ended Throttles (“Type 2”)

With these throttles (“Type 2” in the programming menu) the controller looks for a voltage signal at the wiper input (Pin 15). Zero speed will correspond to 0V and full speed to 5 V. A 3-wire pot, voltage source, voltage sensor, or current source can be used with this throttle type. The wiring for each is slightly different.

0–5V Throttle

Two ways of wiring the 0–5V throttle are shown in Figure 6. The active range for this throttle is from 0.2V (at 0% Throttle Deadband) to 5.0 V (at 100% Throttle Max), measured relative to B-.

Fig. 6 *Wiring for 0–5V throttles (“Type 2”).*

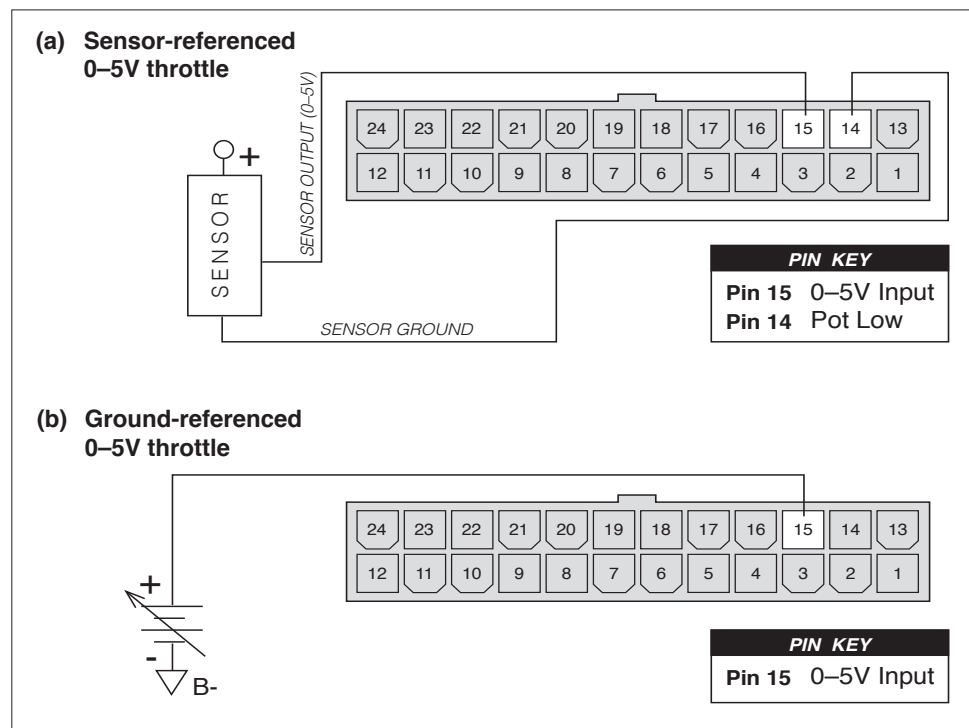

3-Wire Potentiometer ($1k\Omega$ – $10k\Omega$) Throttle

The 3-wire potentiometer is used in its voltage divider mode, with the voltage source and return being provided by the 1244 controller. Pot High (Pin 13) provides a current limited 5V source to the pot, and Pot Low (Pin 14) provides the return path. The pot wiper is then connected to the Wiper Input (Pin 15). If a 3-wire pot is used in the application, the controller will provide full throttle fault protection in accordance with EEC requirements. Potentiometers with total resistance values between $1k\Omega$ and $10k\Omega$ can be used with Throttle Type 2. Wiring is shown in Figure 7.

Fig. 7 Wiring for 3-wire potentiometer throttle (“Type 2”).

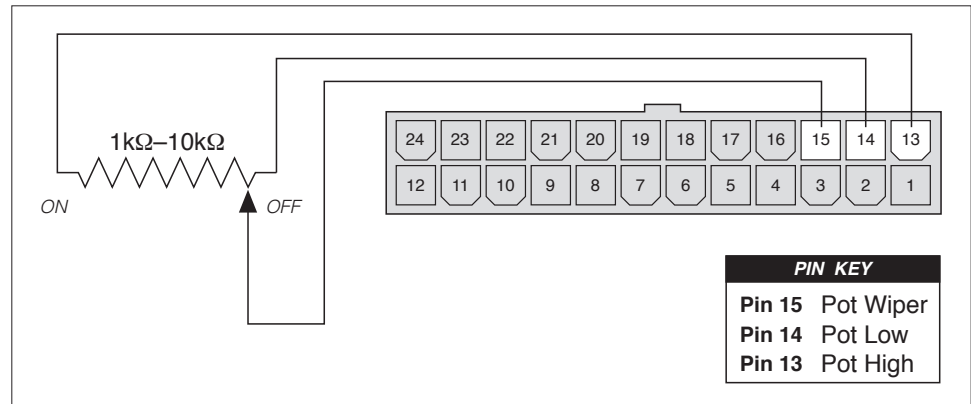

Current Sources As Throttles

A current source can also be used as a throttle input, as shown in Figure 8. A resistor, R_{throttle} , must be used to convert the current source value to a voltage. The resistor should be sized to provide a 0–5V signal variation over the full current range.

Fig. 8 Wiring for current source throttle (“Type 2”).

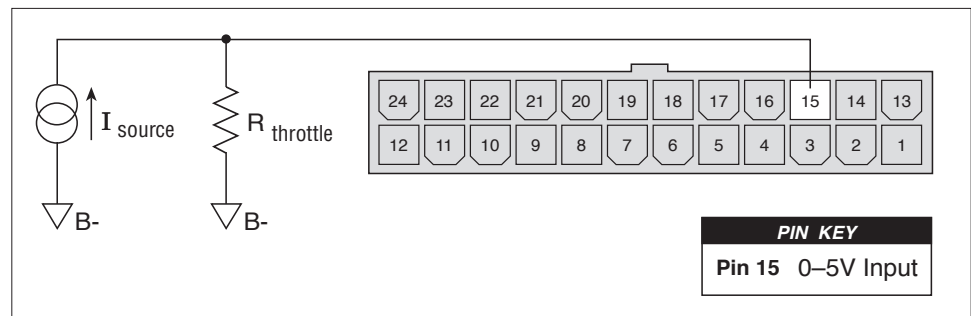

Curtis ET-XXX Electronic Throttle

The Curtis ET-XXX provides a 0–5V throttle and forward/reverse inputs for the 1244 controller. Wiring for the ET-XXX is shown in Figure 9.

Fig. 9 *Wiring for Curtis ET-XXX electronic throttle (“Type 2”).*

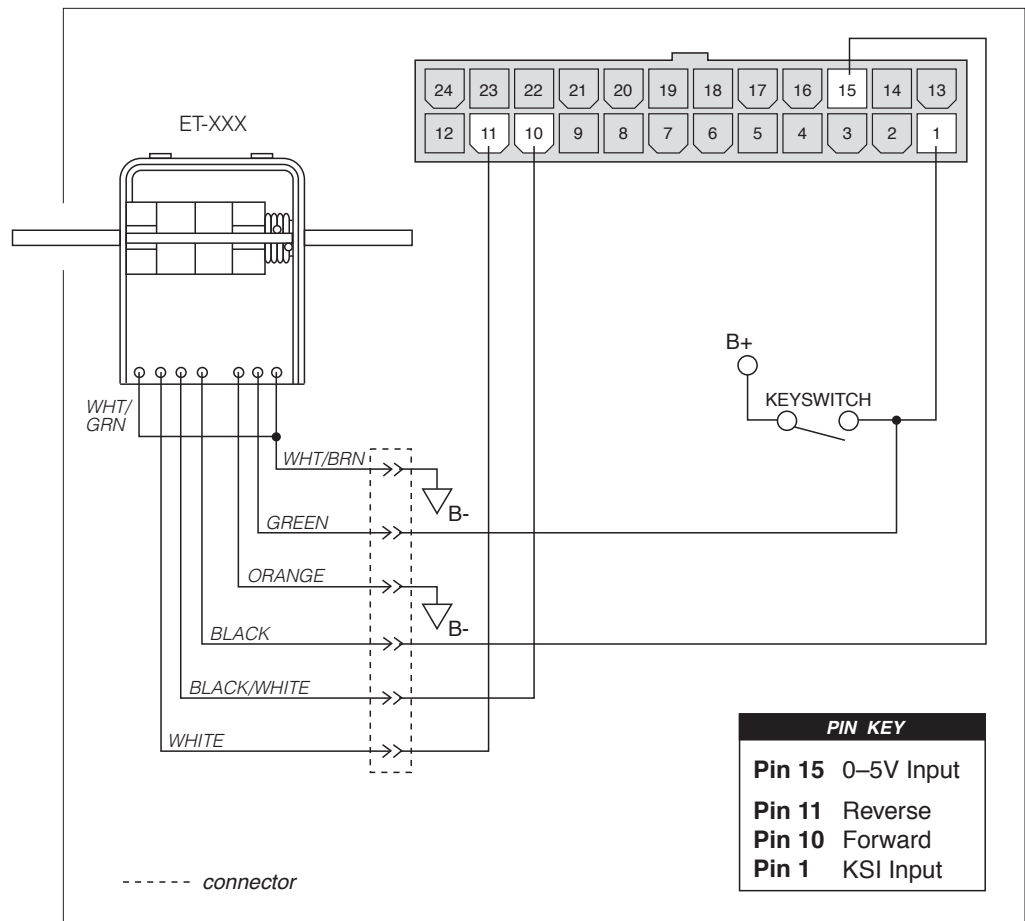

The ET-XXX can be integrated into a control head to provide wigwag-style throttle control. Alternatively, a complete control head assembly is available from Curtis. This control head assembly—the CH series—combines the ET-XXX throttle with a variety of standard control head switch functions for use in walkie and lift truck applications.

0–5k Ω Throttle (“Type 3”)

The 0–5k Ω throttle (“Type 3” in the programming menu) is a 2-wire resistive throttle that connects between the 2-Wire Pot and Pot Low pins (Pins 16 and 14) as shown in Figure 10. Zero speed corresponds to 0 Ω measured between the two pins and full speed corresponds to 5 k Ω . This throttle type is not appropriate for use in wigwag-style applications.

Fig. 10 Wiring for 0–5k Ω throttle (“Type 3”).

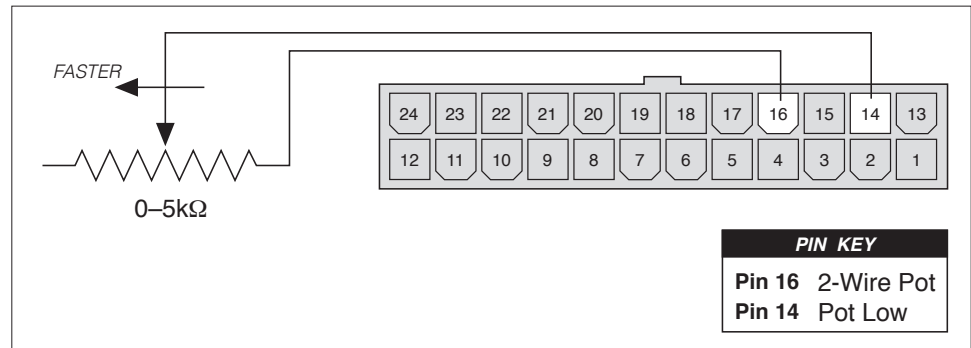

If the total resistance between Pins 14 and 16 is greater than 7.5 k Ω , the controller’s 4.4 V upper fault limit will be exceeded and the controller output will be disabled. This provides broken wire protection, and also serves as an indication that the potentiometer’s nominal value has increased and the pot needs to be replaced.

0–5V and 3-Wire Potentiometer Wigwag-Style Throttles (“Type 4”)

With these throttles (“Type 4” in the programming menu) the throttle can be used in true wigwag style. Any potentiometer value between 1 k Ω and 10 k Ω is supported. If a 5k Ω potentiometer is used, the neutral point will be with the wiper at 2.5 k Ω (measured between the Pot Wiper and Pot Low pins [Pins 15 and 14]). The controller will provide increasing speed in the forward direction as the wiper is moved toward Pot High, with maximum forward speed reached at 4.5 k Ω . The controller will provide increasing speed in the reverse direction as the wiper is moved toward Pot Low, with maximum reverse speed reached at 0.5 k Ω .

A 0–5V voltage source can also be used as the wiper input (see Figure 6). However, the minimum and maximum wiper voltage must not exceed the 0.5V and 4.5V fault limits.

With a Type 4 throttle, no direction signals to the controllers’ forward and reverse inputs are required. Direction is determined by the wiper input value. The throttle interface to the controller is similar to that for Type 2 throttles.

CAN-Nodes Throttle (“Type 5”)

The “Type 5” throttle option is designed for use with CAN-based control systems. No connections are required to the throttle input pins (Pins 13–16) or direction pins (Pins 10 and 11), because all communications are handled through the 6-pin CAN-Nodes interface connector. Details on how to combine a given throttle with the CAN-Nodes system are provided in the Curtis CAN Protocol Document. Fault detection for Type 5 throttles is handled by the CAN CRC (Cyclic Redundancy Check) function, which is part of each node in the CAN Bus architecture.

WIRING: Fault Outputs

The 1244 controller has two fault output drivers, at Pin 5 and Pin 6, which can be used to provide diagnostic information either to a display panel on the vehicle or to a remote location. These outputs are rated at 10mA maximum current at the nominal battery pack voltage. For information on programming these outputs, see Section 3: Programmable Parameters.

Wiring for the Fault 1 and Fault 2 outputs is shown in Figure 11.

Fig. 11 *Wiring for fault outputs.*

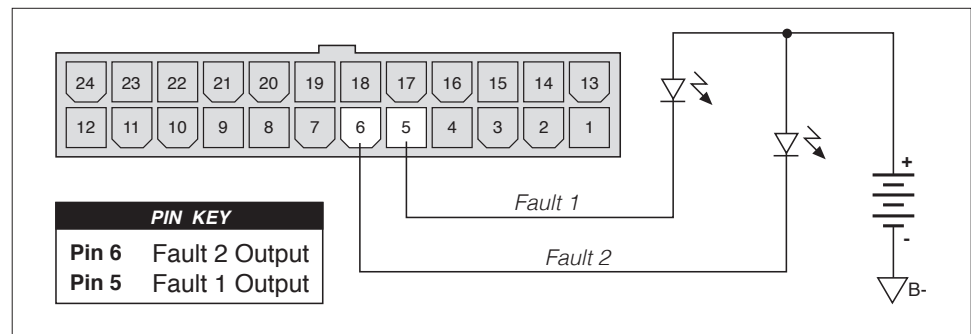

WIRING: Contactor Drivers

The 1244 controller provides contactor coil drivers (at Pins 17–20) for the main contactor, auxiliary contactor, reverse signal, and electromagnetic brake functions. These four outputs are low side drivers, designed to energize contactor coils. The auxiliary, reverse signal, and electromagnetic brake drivers are optional functions. They are available only if the Accessory Driver option is specified—see Section 4, page 50.

It is not necessary to specify the contactors’ coil voltage at the nominal battery pack voltage as long as the Contactor Pull-In Voltage and Contactor Holding Voltage parameters are programmed to accommodate the coils’ voltage rating. However, all coil voltage ratings should be the same, since only one value of pull-in and holding voltage can be specified for all four of the drivers.

The driver outputs are rated at 2 amps and overcurrent protected at 3 amps. The controller can be programmed to check for missing coil faults.

These checks can be disabled using a programmer—see *Section 3, pages 44 and 45*. A coil suppression diode is provided internally to protect the drivers from inductive spikes generated at turn-off. To take advantage of the controller's internal coil suppression diode, Pin 9 must be wired such that the return path to the contactor drivers cannot be opened by any switches or contactors.

The driver loads are not limited to contactor coils. Any load can be connected to a Pin 17–20 driver as long as it does not exceed the driver's 2 amp current rating.

For information on programming the various contactor-related parameters, see *Section 3: Programmable Parameters*.

Main Contactor Driver

In the standard configuration, the main contactor driver (Pin 17) pulls low when the keyswitch input is enabled; this wiring is shown in the standard wiring diagram (Figure 3, page 8).

Alternatively, the main contactor driver can be programmed not to pull low until the interlock input as well as the keyswitch input is enabled. To do this, the Main Contactor Driver Interlock parameter must be set to "On." If the Main Contactor Driver Interlock parameter is On, the Main Contactor Dropout Delay parameter can be set to allow the main contactor to remain engaged for up to 40 seconds after the interlock signal has been disabled. If the interlock and delay functions are used, the main contactor and the coil return (Pin 9) must both be wired to KSI. This alternative wiring is shown in Figure 12.

Auxiliary Contactor Driver

Like the main contactor driver, the auxiliary contactor driver (Pin 18) pulls low when the interlock input is enabled. The output will be pulse-width-modulated at the coil holding voltage along with the main, reverse signal, and electromagnetic brake contactor drivers, if the Holding Voltage parameter is set to less than 100%.

If desired, the Auxiliary Contactor Dropout Delay parameter can be set to allow the auxiliary contactor to remain engaged for up to 40 seconds after the interlock signal has been disabled. If the delay function is used, the auxiliary contactor and the coil return (Pin 9) must both be wired to KSI rather than the interlock input. This alternative wiring is shown in Figure 12.

Reverse Signal Driver

The reverse signal driver (Pin 19) pulls low when the vehicle is moving in the reverse direction, either in drive or in braking mode. This driver is designed to drive a reverse signal beeper or warning lamp that operates when one input is pulled low. The output will be pulse-width-modulated at the coil holding voltage along with the main, auxiliary, and electromagnetic brake contactor drivers, if the holding voltage parameter is set to less than 100%.

Fig. 12 *Wiring for main, auxiliary, reverse signal, and electromagnetic brake contactor coils, using the interlock and dropout delay functions.*

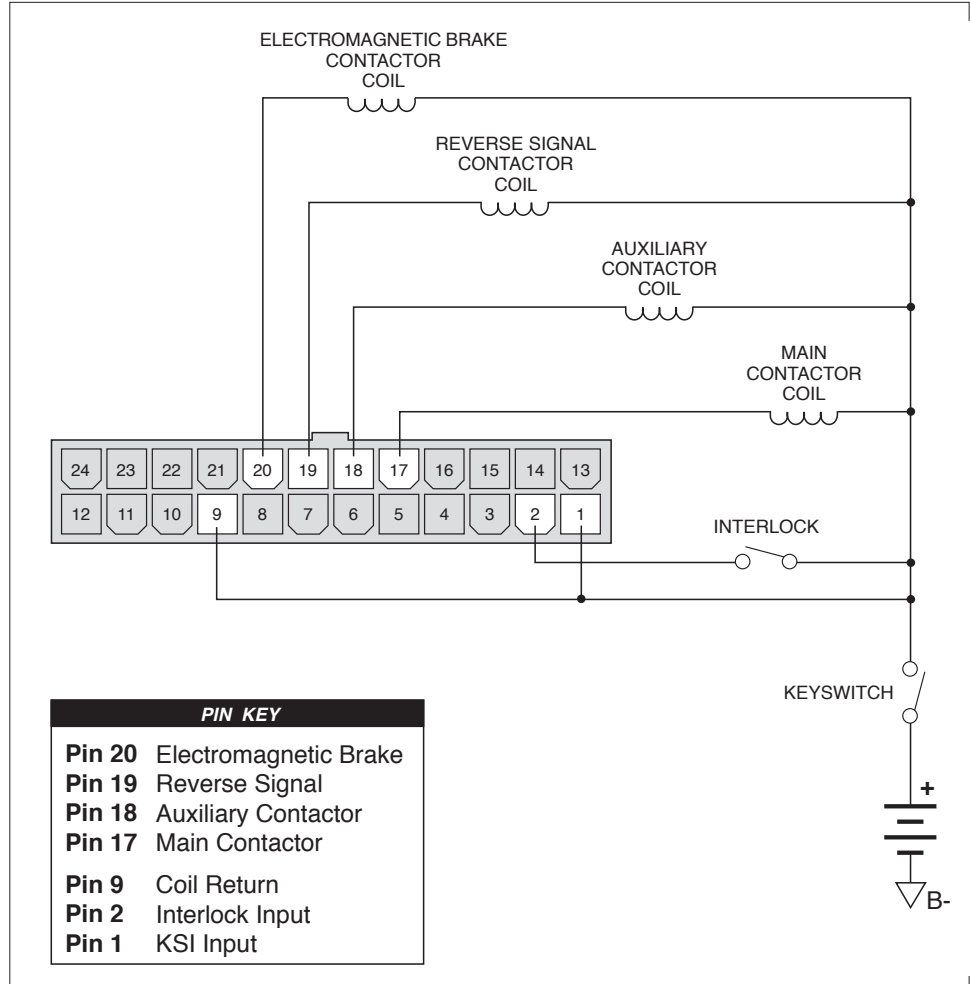

Electromagnetic Brake Driver

The electromagnetic brake driver (Pin 20) pulls low when the controller receives a throttle request or detects that the vehicle is still in braking mode. If desired, the Brake Delay parameter can be set to allow the brake to remain disengaged for up to 5 seconds after braking to neutral has been completed. If the delay function is used, the brake driver and the coil return (Pin 9) must both be wired to KSI rather than the interlock input. This alternative wiring is shown in Figure 12.

If the Throttle Braking parameter has been set to zero, the brake delay time begins when the throttle is returned to neutral and the PWM output decelerates to zero. The output will be pulse-width-modulated at the coil holding voltage along with the main, auxiliary, and reverse signal contactor drivers, if the holding voltage parameter is set to less than 100%.

WIRING: Pedal Switch

When the Pedal Switch option is enabled, controller output is possible only when the pedal input (Pin 8) is pulled to B+. This feature allows a switch connected to the throttle mechanism to guarantee zero controller output when the operator releases the throttle. This adds a safety feature to protect against throttle failures that cause controller output when the throttle is in neutral.

Alternatively, the pedal input can be wired into the brake pedal circuit to automatically force zero controller output when the brake pedal is depressed, regardless of throttle request.

WIRING: Hour Meter

The hour meter output (Pin 12) pulls to B+ to enable an hour meter whenever current is flowing in the motor. This allows accurate accumulation of vehicle operating hours. The output is current limited to 20 mA, and is compatible with Curtis 700 and 800 series hour meters. For wiring, consult the documentation supplied with the hour meter.

WIRING: CAN Bus Interface

Refer to the Curtis CAN Protocol Document for information about the CAN Bus interface.

WIRING: Emergency Reverse

If you are installing a 1244 controller in a walkie vehicle, the emergency reverse switch should be wired to Pin 7, as shown in Figure 13.

Fig. 13 *Wiring for emergency reverse (applicable to walkie vehicles only).*

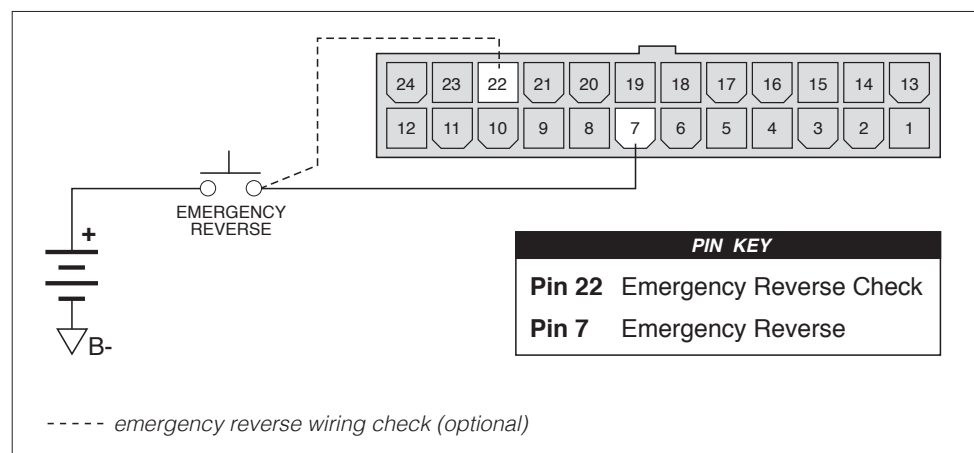

Emergency reverse is activated when the keyswitch is On and the emergency reverse input is pulled to B+ by closing the emergency reverse switch. After the emergency reverse switch is released, normal controller operation is



not resumed until neutral (no direction) is selected or until the interlock switch is cycled. **CAUTION:** The polarity of the **F1** and **F2** connections will affect the operation of the emergency reverse feature. The forward and reverse switches and the **F1** and **F2** connections must be configured so that the vehicle drives away from the operator when the emergency reverse button is pressed.

An optional wire connected directly to the emergency reverse switch provides for broken wire protection when that feature is enabled by the OEM. The emergency reverse check feature periodically pulses the emergency reverse circuit to check for continuity in the wiring. If there is no continuity, controller output is inhibited until the wiring fault is corrected. The emergency reverse wiring check wire (see dotted line in Figure 13) should be connected to the emergency reverse switch terminals and to Pin 22.

For information about the emergency reverse parameters, see Section 3: Programmable Parameters.

CONTACTOR, SWITCHES, and OTHER HARDWARE

Main Contactor

A main contactor is recommended for use with any 1244 controller. A main contactor allows the controller and motor to be disconnected from the battery. This provides a significant safety feature in that the battery power can be removed from the drive system if a controller or wiring fault results in battery power being applied to the motor.

A single-pole, single-throw (SPST) contactor with silver-alloy contacts is recommended for use as the main contactor. It is not necessary to specify the coils at the nominal battery pack voltage as long as the Contactor Pull-In Voltage and Contactor Holding Voltage are programmed to accommodate the coil's voltage rating—*see Section 3, page 46*. The contactor coil should be specified with a continuous rating if the Holding Voltage parameter is to be set at 100%. Intermittent duty coils can be specified if they are used with appropriate Holding Voltage values.

Keyswitch and Interlock Switch

The vehicle should have a master on/off switch to turn the system off when not in use. The keyswitch input provides logic power for the controller. The interlock switch provides a safety interlock to prevent operation when a mechanical brake is engaged or to ensure operator presence before the vehicle is allowed to move. The keyswitch and interlock switch provide current to drive the various contactor coils as well as the controller's internal logic circuitry and must be rated to carry these currents.

Forward, Reverse, Mode Select, and Pedal Switches

These input switches can be any type of single-pole, single-throw (SPST) switch capable of switching the battery voltage at 25 mA.

Reverse Polarity Protection Diode

For reverse polarity protection, a diode should be added to the control circuit. This diode will prohibit main contactor operation and current flow if the battery pack is accidentally wired with the B+ and B- terminals reversed. It should be sized appropriately for the maximum contactor coil and fault diode currents required from the control circuit. The reverse polarity protection diode should be wired as shown in the standard wiring diagram (Figure 3, page 8).

Circuitry Protection Devices

To protect the control circuitry from accidental shorts, a low current fuse (appropriate for the maximum current draw) should be connected in series with the battery feed to the keyswitch. Additionally, a high current fuse should be wired in series with the main contactor to protect the motor, controller, and batteries from accidental shorts in the power system. The appropriate fuse for each application should be selected with the help of a reputable fuse manufacturer or dealer. The standard wiring diagram (Figure 3, page 8) shows the recommended location for each fuse.

Mode Select Switch Operation

The two mode select switches (Mode Select 1 and Mode Select 2) together define the four operating modes. The switch combinations are shown in Table 2. Wiring for the mode select switches is shown in the standard wiring diagram (Figure 3, page 8).

OPERATING MODE	MODE SELECT SWITCH 1	MODE SELECT SWITCH 2
MultiMode™ 1	OPEN	OPEN
MultiMode™ 2	CLOSED	OPEN
MultiMode™ 3	OPEN	CLOSED
MultiMode™ 4	CLOSED	CLOSED

3

PROGRAMMABLE PARAMETERS

The 1244 controller has a number of parameters that can be programmed by means of a 1313 handheld programmer or 1314 PC Programming Station. These programmable parameters allow the vehicle's performance characteristics to be customized to fit the needs of individual vehicles or vehicle operators.

Each controller is shipped with the parameter settings specified by the OEM. For each programmable parameter, the specification process includes designating whether it is to have User or OEM-only access rights. The OEM specifies which—if any—parameters the user (dealer, distributor, etc.) will be able to adjust. Accordingly, Curtis offers two versions of the programmers: for example, the 1313-1109 is the User handheld programmer (which can adjust only those parameters with User access rights) and the 1313-4409 is the OEM programmer (which can adjust all the programmable parameters).

The MultiMode™ feature of these controllers allows operation in four distinct modes. These modes can be programmed to provide four different sets of operating characteristics, which can be useful for operating in different conditions—such as slow precise indoor maneuvering in one mode; faster, long distance, outdoor travel in another mode; and application-specific special conditions in the remaining two modes.

Eight parameters can be configured independently in the four modes:

- acceleration rate (M1–M4)
- braking rate (M1–M4)
- maximum speed (M1–M4)
- creep speed (M1–M4)
- throttle map (M1–M4)
- throttle braking percent (M1–M4)
- drive current limit (M1–M4)
- braking current limit (M1–M4).

Controllers can be factory-set to allow only one mode of operation if a MultiMode™ system is not desirable for the application—see Section 4. It is not necessary to have all eight MultiMode™ parameters on or off together; one or any combination of these parameters can be specified as single-mode and the others specified as MultiMode™.

The programmable parameters are described in the following order. They are listed in the text by the abbreviated names that are displayed by the programmer. Not all of these parameters are displayed on all controllers; the list for any given controller depends on its specifications.

There are additional parameters that can only be configured at the factory. The manufacturer can specify how these parameters will be configured, but they are not programmable using the programmer. See Section 4: OEM Specified, Factory Set Parameters.

Acceleration Parameters

- Acceleration Rate, M1–M4
- Braking Rate, M1–M4
- Deceleration Rate
- Quick Start
- Taper Rate

Speed Parameters

- Maximum Speed, M1–M4
- Creep Speed, M1–M4
- Regen Speed

Throttle Parameters

- Control Mode
- Throttle Type
- Throttle Deadband
- Throttle Maximum
- Throttle Map, M1–M4
- Throttle Braking Percent, M1–M4

Current Limit Parameters

- Drive Current Limit, M1–M4
- Braking Current Limit, M1–M4
- Minimum Field Current Limit
- Maximum Field Current Limit
- Restraint
- Emergency Reverse Current Limit
- Current Ratio

Field Control Parameters

Field Map Start
Field Map

Fault Parameters

High Pedal Disable (HPD)
HPD Threshold
Static Return to Off (SRO)
Fault Code

Output Driver Parameters

Main Contactor Driver Interlock
Main Contactor Dropout Delay
Main Coil Open Check
Main Contactor Weld Check
Auxiliary Driver Dropout Delay
Auxiliary Coil Open Check
Reverse Signal Open Check
Electromagnetic Brake Delay
Electromagnetic Brake Open Check
Contactor Holding Voltage
Contactor Pull-In Voltage

Other Parameters

Battery Voltage
Anti-Tiedown
Sequencing Delay
Pedal Interlock
Emergency Reverse Enable
Emergency Reverse Check
Node Address
Precharge
Load Compensation

Acceleration Parameters

M1–M4, ACCEL RATE

The **acceleration rate** defines the time it takes the controller to accelerate from 0% output to 100% output. A larger value represents a longer acceleration time and a gentler start. Fast starts can be achieved by reducing the acceleration time, i.e., by adjusting the accel rate to a smaller value. The acceleration rate is adjustable from 0.1 second to 5.0 seconds, in 0.1 second increments. It can be set independently for each of the four operating modes.

M1–M4, BRAKE RATE

The **braking rate** defines the time it takes the controller to increase from 0% regen braking current to 100% regen braking current when braking is requested. A larger value represents a longer time and therefore a gentler increase in braking strength. Full braking strength is achieved more quickly when the braking rate parameter value is reduced. The braking rate is adjustable from 0.1 second to 5.0 seconds, in 0.1 second increments, and can be set independently for each of the four operating modes.

DECEL RATE

The **deceleration rate** defines the time it takes the controller output to respond to a decrease in applied throttle. The deceleration rate defines the vehicle's braking characteristic for any reduction in throttle, including to neutral, that does not include a request for the opposite direction. It also defines the characteristic for braking after Emergency Reverse is released. The decel rate is adjustable from 0 to 10 seconds, in 0.1 second increments. The decel rate works in conjunction with the throttle braking percent parameter, which must be set greater than zero for the programmed decel rate to be active. The decel rate is not a MultiMode™ parameter, and its value will therefore affect all four operating modes.

QUICK START

The **quick start** function provides faster than normal acceleration in response to fast changes in throttle demand. Upon receiving a sudden high throttle demand from neutral, the quick start function causes the controller to exceed its normal acceleration rate. The quick start algorithm is applied each time the throttle passes through neutral and the controller is not in braking mode. Quick start is adjustable from 0 to 10, in increments of 1. Increasing the value “liven” the vehicle's acceleration response to fast throttle movements.

TAPER RATE

The **taper rate** parameter sets the rate at which the regenerative braking command ramps down at the completion of regen braking. This controls the feel of the vehicle as it slows down and approaches zero speed. The taper rate should be adjusted such that during a full speed direction transition, the vehicle comes to a smooth stop before accelerating in the opposite direction. The taper rate parameter is adjustable from 0 to 64 in increments of 1, with each increment representing 1/32 of a second. This parameter is not active during plug braking.

Speed Parameters

M1–M4, MAX SPEED

The **maximum speed** parameter defines the maximum controller output at full throttle. This parameter is adjustable from 0% to 100%, in 1% increments.

M1–M4, CREEP SPEED

The **creep speed** parameter defines the initial controller output generated when a direction is first selected. No applied throttle is necessary for the vehicle to enter the creep mode, only a direction signal. The output maintains creep speed until the throttle is rotated out of the throttle deadband (typically 10% of throttle).

Creep speed is adjustable from 0% to 25% of the controller duty cycle, in 1% increments. The specified creep speed percentage is not displayed as a throttle percent in the programmer's Test Menu when a direction is selected and zero throttle is applied; only the throttle command is displayed.

REGEN SPEED

The **regen speed** parameter defines the vehicle speed above which the controller initiates regenerative braking; below this speed, plug braking is used. Once the vehicle begins regen braking, the system will continue to regen brake all the way to zero speed. This threshold is important as it will affect the smoothness of direction transitions when jockeying between forward and reverse at low speeds. Regen braking provides the most benefit when the vehicle is decelerated from fast speeds, whereas plug braking provides noticeably smoother direction changes at slow speeds. The regen speed parameter is adjustable from 0% to 100% of the vehicle speed, in 1% increments. Recommendations for adjusting the regen braking parameter are provided in Section 6: Vehicle Performance Adjustment.

Throttle Parameters

CTRL MODE

The **control mode** parameter tailors the controller's output response to throttle commands. The two control modes allow the throttle position to define either applied motor current or applied motor voltage.

In current control mode (Type 0), the throttle position controls the current flowing in the motor. The controller varies the percentage of battery voltage applied to the motor to achieve the requested motor current, thus controlling the motor torque. The operator will increase throttle demand to accelerate and reduce the throttle demand once the desired vehicle speed is reached. Any conditions that result in an increase in motor loading or more motor torque will require an increase in throttle demand to maintain the same vehicle speed. The throttle braking percent, current ratio, and decel rate parameters are not active in the current control mode.

In voltage control mode (Type 1), the throttle position controls the percentage of battery voltage and current applied to the motor. The current that is allowed to flow in the motor can be modified using the current ratio parameter; see page 38. In voltage control mode, changes in motor loading will result in only a small change in vehicle speed unless the current limit is reached.

Acceleration and deceleration characteristics of the vehicle in response to throttle changes in any of these modes will be determined by tuning parameters such as accel rate, quick start, etc.

THROTTLE TYPE

The 1244 controller accepts a variety of throttle inputs, through various combinations of its four throttle input pins. The most commonly used throttles can be hooked up directly: $5\text{k}\Omega$ –0 and 0– $5\text{k}\Omega$ 2-wire rheostats, 3-wire pots, 0–5V throttles, Curtis ET-XXX electronic throttles, and CAN-Nodes based throttles.

The standard throttle input signal type options—Types “1” through “5” in the throttle type programming menu—are listed in Table 3. Wiring information and performance characteristics for each throttle type are presented in Section 2.

THROTTLE TYPE	DESCRIPTION
1	$5\text{k}\Omega$ –0, 2-wire rheostat
2	single-ended 3-wire potentiometer ($1\text{k}\Omega$ to $10\text{k}\Omega$ range) or single-ended 0–5V input (from voltage throttle, Curtis ET-XXX electronic throttle, or current source)
3	0– $5\text{k}\Omega$, 2-wire rheostat
4	wigwag 3-wire potentiometer ($1\text{k}\Omega$ to $10\text{k}\Omega$ range) or wigwag 0–5V input (from voltage throttle)
5	CAN-Nodes throttle

THRTL DEADBAND

The **throttle deadband** parameter defines the throttle pot wiper voltage range the controller interprets as neutral. Increasing the throttle deadband setting increases the neutral range. This parameter is especially useful with throttle assemblies that do not reliably return to a well-defined neutral point, because it allows the deadband to be defined wide enough to ensure that the controller goes into neutral when the throttle mechanism is released.

Examples of deadband settings (30%, 10%, 0%) are shown in Figure 14 for throttle types 1 through 4, using a nominal $5\text{k}\Omega$ -0 potentiometer. (For throttle type 5, see the Curtis CAN Protocol Document.)

Fig. 14 Effect of adjusting the throttle deadband parameter (Throttle Types 1 and 2).

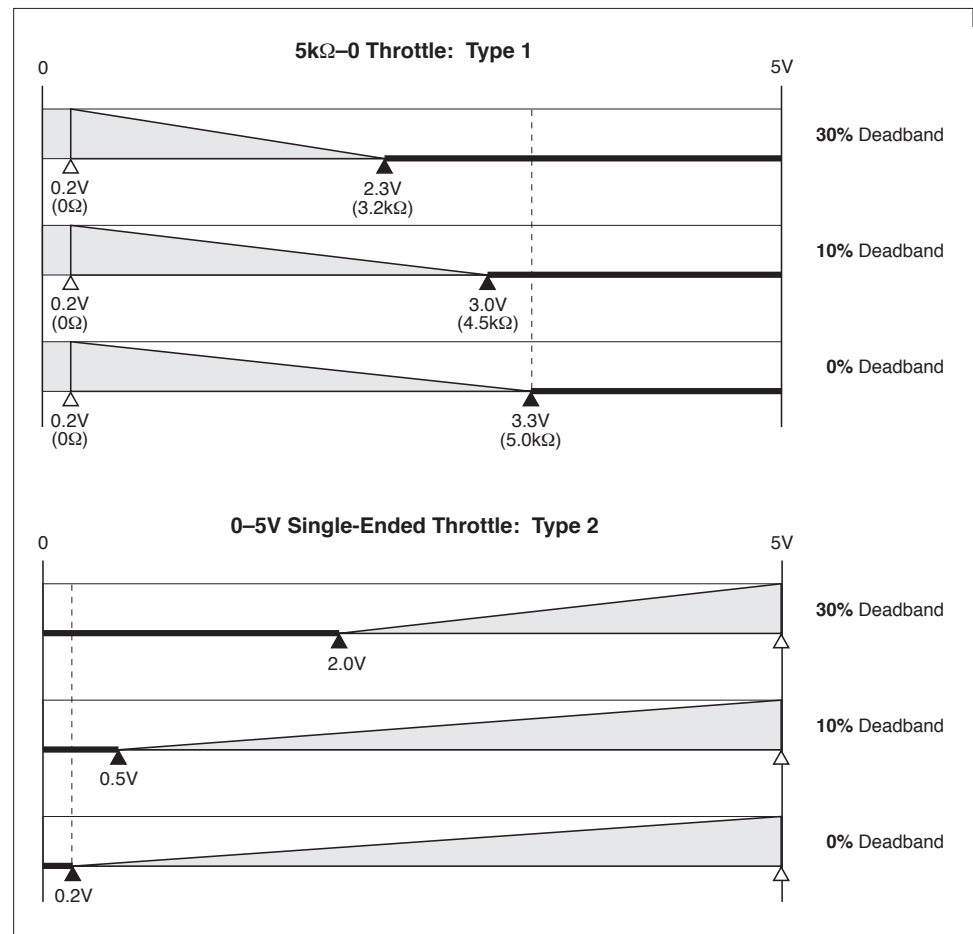
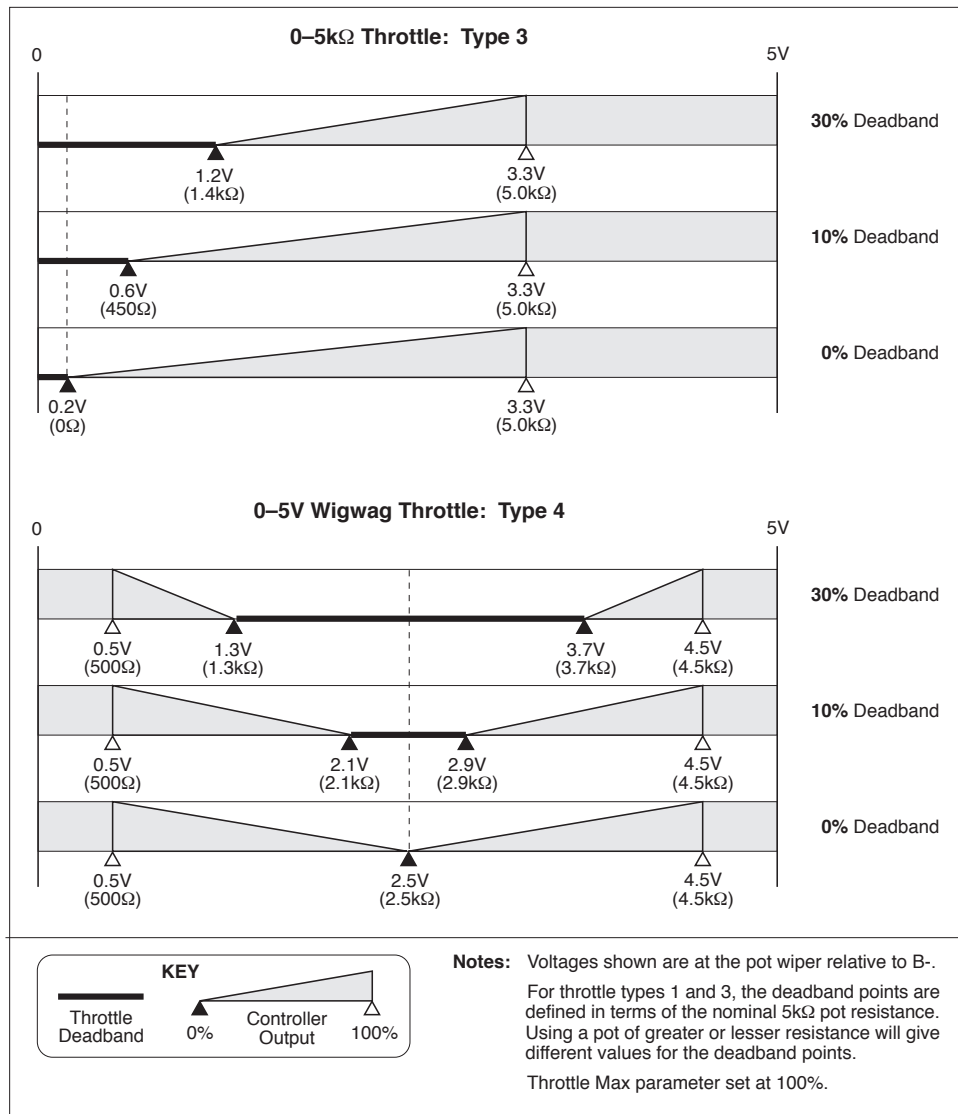

Fig. 14, cont'd *Effect of adjusting the throttle deadband parameter (Throttle Types 3 and 4).*



The programmer displays the throttle deadband parameter as a percentage of the nominal throttle wiper voltage range and is adjustable from 0% to 30%, in 2% increments. The default deadband setting is 10%. The nominal throttle wiper voltage range depends on the throttle type selected. See Table 1 (page 10) for the characteristics of your selected throttle type.

THROTTLE MAX

The **throttle max** parameter sets the wiper voltage required to produce 100% controller output. Decreasing the throttle max setting reduces the wiper voltage and therefore the full stroke necessary to produce full controller output. This feature allows reduced-range throttle assemblies to be accommodated.

Examples are shown in Figure 15 for throttle types 1 through 4, using a nominal 5kΩ potentiometer. These examples illustrate the effect of three different throttle max settings (100%, 90%, 60%) on the full-stroke wiper voltage required to attain 100% controller output.

Fig. 15 Effect of adjusting the throttle max parameter (Throttle Types 1 and 2).

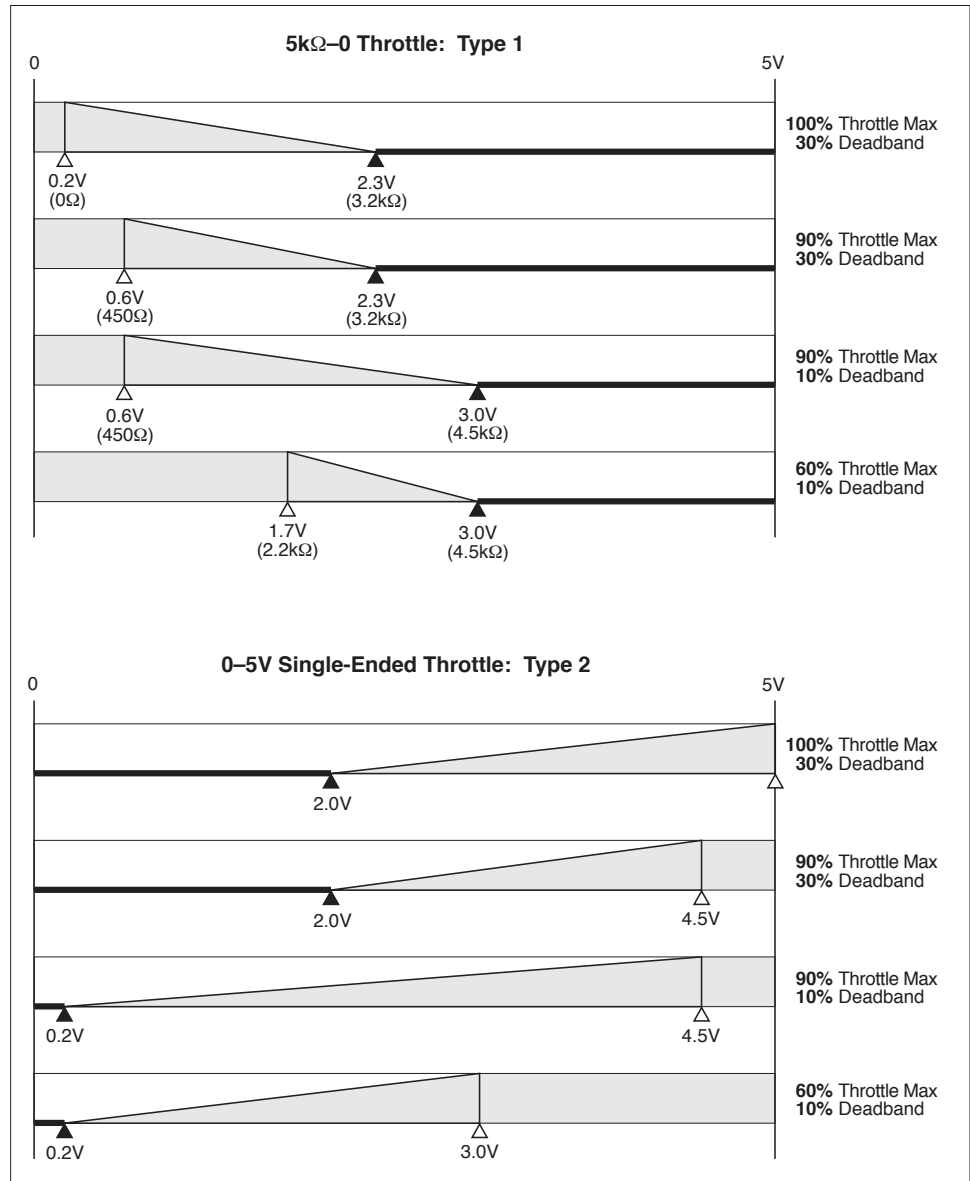
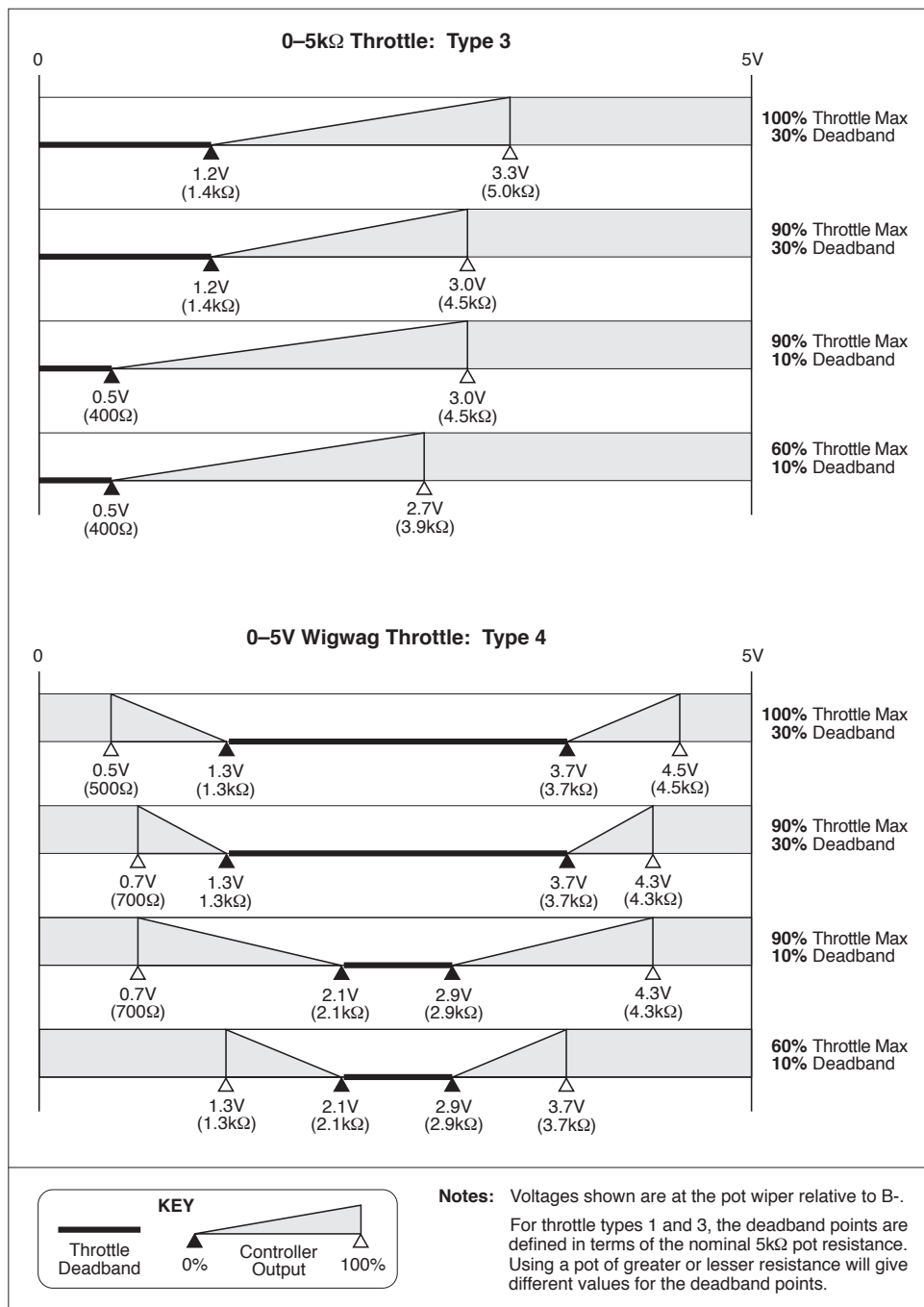

Fig. 15, cont'd
Effect of adjusting the throttle max parameter (Throttle Types 3 and 4).



The programmer displays the throttle max parameter as a percentage of the active throttle voltage range. The throttle max parameter can be adjusted from 100% to 60%, in 2% increments. The nominal throttle wiper voltage range depends on the throttle type selected. See Table 1 (page 10) for the characteristics of your selected throttle type.

M1–M4, THRTL MAP

The **throttle map** parameter modifies the vehicle's response to the throttle input. This parameter determines the controller output, based on the selected throttle control mode, for a given amount of applied throttle. Setting the throttle map parameter at 50% provides a linear output response to throttle position. Values below 50% reduce the controller output at low throttle settings, providing enhanced slow speed control. Values above 50% give the vehicle a faster, jumpier feel at low throttle settings.

The throttle map can be programmed in 5% increments between 20% and 80%. The number refers to the controller output at half throttle, as a percentage of the throttle's full active range. The throttle's active range is the voltage or resistance between the 0% output point (throttle deadband) and the 100% output point (throttle max). For example, if maximum speed is set at 100% and creep speed is set at 0, a throttle map setting of 50% will give 50% output at half throttle. The 50% setting corresponds to a linear response. Six throttle map profiles (20, 30, 40, 50, 60, and 80%) are shown as examples in Figure 16, with the maximum speed set at 100% and the creep speed set 0.

Fig. 16 *Throttle maps for controller with maximum speed set at 100% and creep speed set at 0.*

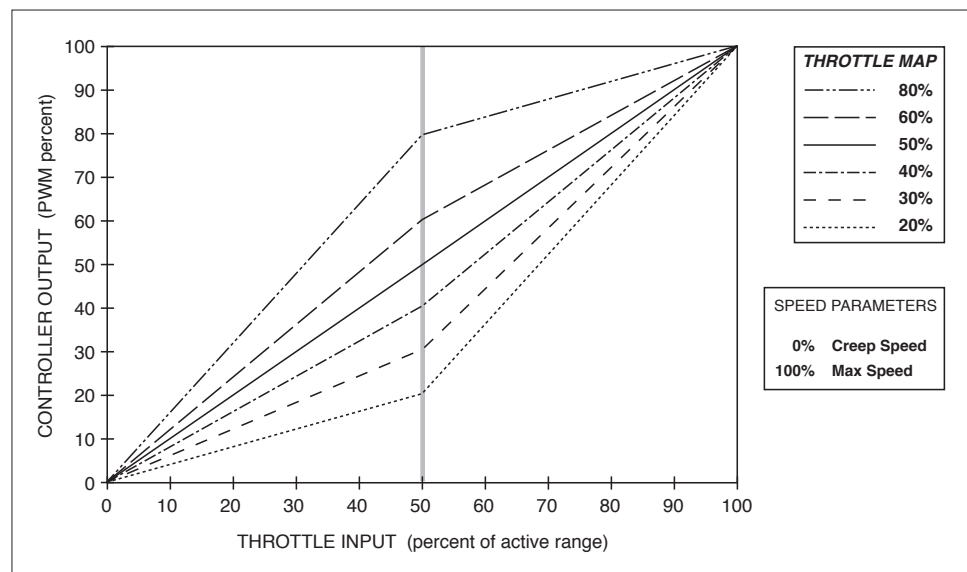

Lowering the max speed or raising the creep speed limits the controller's output range. Throttle map profiles with the creep speed raised from zero to 10% and the max speed reduced from 100% to 80% are shown in Figure 17. The throttle map is always a percentage of the controller's output range. So, in these examples, the throttle map is a percentage of the 10–80% output range; a 40% throttle map setting will give 38% output at half throttle (40% of the 70% range, which is 28%, shifted up to 38% because it starts at the 10% creep speed). Controller output will begin to increase above the set creep speed as soon as the throttle is rotated out of its normal neutral range (deadband). Controller output will continue to increase, following the curve defined by the

throttle map setting, as the throttle input increases and will reach maximum output when the throttle input enters the upper deadband (crosses the throttle max threshold).

Fig. 17 Throttle maps for controller with maximum speed set at 80% and creep speed set at 10%.

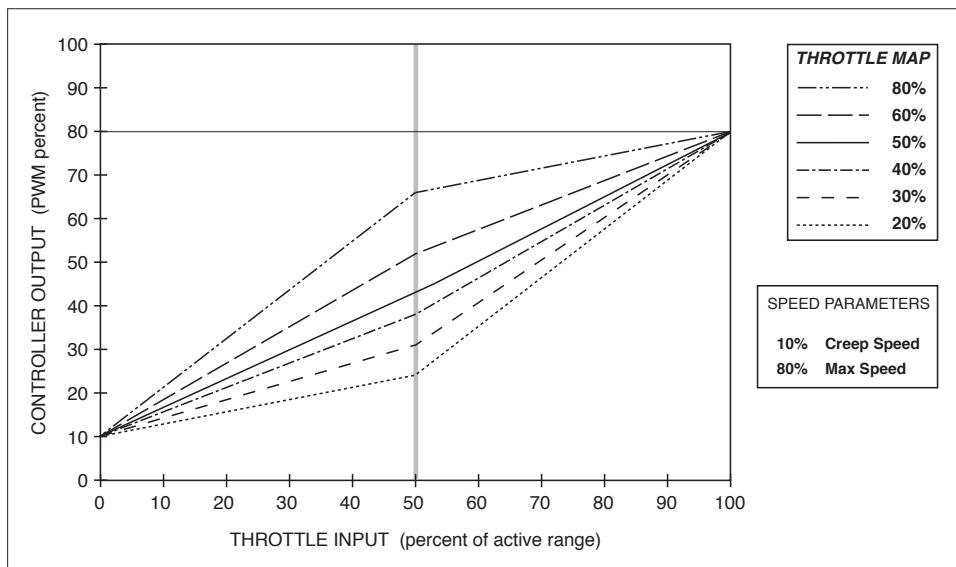

The Throttle Map operates within the window established by the Creep Speed, Max Speed, Throttle Deadband, and Throttle Max parameters, as shown in Figure 18. Creep Speed and Max Speed define the controller’s output range, while Throttle Deadband and Throttle Max define the throttle’s active range. These four parameters, together with the Throttle Map, determine the controller’s output response to throttle demand.

Fig. 18 Influence of various parameters on controller output response to throttle demand.

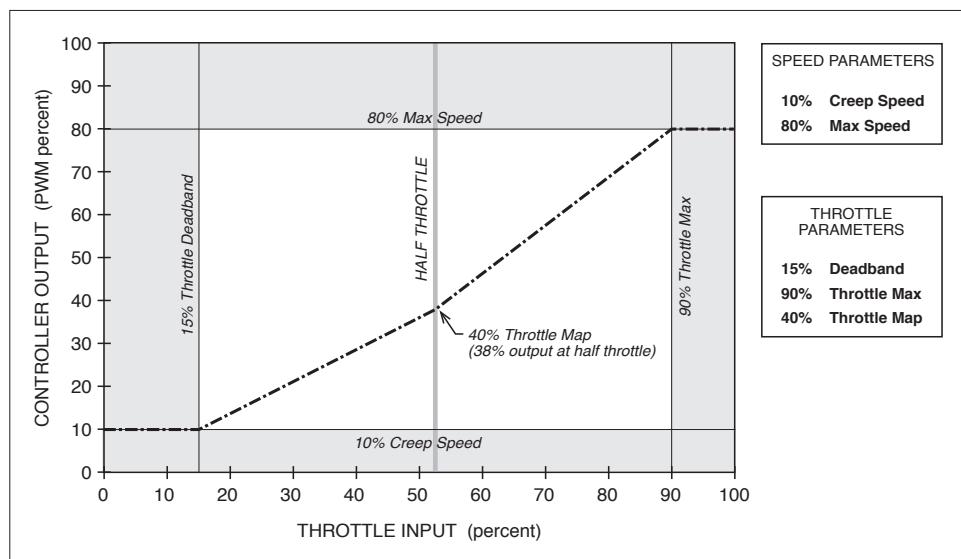

M1–M4, THRT BRK %

The **throttle braking percent** parameter establishes the braking force applied to the vehicle when the throttle is reduced. Throttle braking is engaged when the controller transitions from drive to neutral. The controller recognizes neutral as the condition where neither direction switch is closed, regardless of throttle input. This parameter is adjustable from 0% to 100% of the regen braking current limit specified for a given mode, in 2% increments.

Current Limit Parameters

M1–M4, DRIVE C/L

The **drive current limit** parameter allows adjustment of the maximum current the controller will supply to the motor during drive operation. This parameter can be used to reduce the maximum torque applied to the drive system by the motor in any of the modes. The drive current limit is adjustable from 200 amps to the controller's full rated current, in 5 amp increments. The full rated current depends on the controller model.

M1–M4, BRAKE C/L

The **braking current limit** parameter allows adjustment of the maximum current the controller will supply to the motor during regen braking operations. During regen braking, this parameter controls the regen current from the motor's armature into the battery. The braking current limit is adjustable from 100 amps up to the controller's full rated current, in 5 amp increments. The full rated current depends on the controller model.

FIELD MIN

The **minimum field current limit** parameter defines the minimum allowed current in the motor's field winding. Its setting will determine the vehicle's maximum speed and, to some extent, the smoothness with which the vehicle starts and transitions from one direction to another. If the Field Min value is set high, the vehicle's top speed will be reduced, but torque bumps may be evident when the vehicle is inched or changes direction.

One of the greatest advantages of the Field Min parameter is that it will prevent uncontrolled acceleration when the vehicle encounters a decline. The vehicle's speed is limited when it goes down ramps or when it is unloaded from trucks, etc.

The Field Min parameter is adjustable from 2 to 20 amps, in 0.5 amp increments. Recommendations for adjusting the Field Min parameter are provided in Section 6: Vehicle Performance Adjustment.

FIELD MAX

The **maximum field current limit** parameter defines the maximum allowed current in the motor's field winding. Its setting will determine the motor's maximum torque during both drive and braking, and will limit the power dissipation in the field winding itself. The Field Max parameter is adjustable from 7.5 amps to the controller's full rated field current limit, in 0.5 amp increments. Recommendations for adjusting the Field Max parameter are provided in Section 6: Vehicle Performance Adjustment.

RESTRAINT

Because the 1244 controller is configured to provide throttle braking, overspeed will cause the controller to create a braking current and thus limit or "restrain" the overspeed condition. The **restraint** parameter, in combination with throttle braking percent parameter, determines how strongly the controller will attempt to limit the vehicle speed to the existing throttle setting. This function works at all throttle settings, including zero throttle. It is applicable when throttle is reduced or when the vehicle begins to travel downhill.

The restraint parameter is adjustable from 1 to 10. Setting the parameter to a high value will cause strong braking, in an effort to bring the vehicle speed down to the requested speed. Setting the restraint value to 1 will result in minimal regen braking.

At zero throttle, the restraint function will also attempt to keep the motor at zero speed. This will help hold the vehicle from running away down ramps when braking to neutral is completed and the mechanical or electromagnetic brake has not engaged. The higher the restraint parameter value, the stronger the braking force applied to the motor and the slower the vehicle will creep down the ramp. This creeping speed will depend on the restraint setting, the steepness of the ramp, and the vehicle load. The restraint feature can never hold a vehicle perfectly stationary on a ramp and is not intended to replace a mechanical or electromagnetic brake for this purpose. The throttle braking percent parameter is not active in this situation, and the controller will supply up to the maximum programmed regen current limit. Recommendations for adjusting the restraint parameter are provided in Section 6: Vehicle Performance Adjustment.

EMR REV C/L

The **emergency reverse current limit** parameter defines the maximum braking current provided through the motor when the emergency reverse function is engaged. The emergency reverse current limit is adjustable from 50 amps to the controller's full rated braking current limit, in 5 amp increments.

CURRENT RATIO

The **current ratio** parameter defines how much of the programmed drive current will be available to the motor at reduced throttle requests. This will determine the maximum torque the motor can provide at partial throttle. The current ratio parameter can be set to 1, 2, 4, or 8. These settings represent a multiplication factor applied to the current that would otherwise be available. For example, if 20% throttle is requested with the current ratio set at 1, 20% of the battery voltage and 20% of the drive current will be allowed to flow in the motor (assuming a 50% throttle map setting). If the current ratio is set at 2 under these same conditions, 40% of the current will be available; if it is set at 4, 80%. The controller will never allow more than the programmed drive current to flow in the motor. If the current ratio is set at 8 with 20% throttle requested, the controller will allow only 100% of the drive current and not 160%.

Because the current ratio parameter affects how much torque the motor can provide, high current ratio settings will result in improved ramp climbing with partial throttle, but may cause too much jumpiness at startup.

NOTE: The current ratio parameter is valid only when the control mode parameter is set to Type 1 (Voltage Control).

Field Control Parameters

FLD MAP START

The **field map start** parameter defines the armature current at which the field map starts to increase from the Field Min value. This parameter is expressed in amperes, and is adjustable from 0 to one half the controller's full rated armature current value, in 5 amp increments. The Field Map Start parameter is used to equalize the vehicle's maximum speed when loaded and unloaded.

Increasing the Field Map Start value increases the maximum load the vehicle can carry while still maintaining maximum speed on a level surface. Whether the vehicle's loaded speed will actually increase depends on the armature current being drawn at that load. If the armature current is already below the Field Map Start setting, increasing the Field Map Start value will not affect the vehicle's loaded speed.

Care should be taken to ensure that high Field Map Start values do not move the motor's operating characteristics outside its safe commutation area. Recommendations for adjusting the Field Map Start parameter to achieve various performance characteristics are provided in Section 6: Vehicle Performance Adjustment Guidelines.

FIELD MAP

The **field map** parameter defines the variation of the field winding current as a function of armature current. It controls how much field current is applied for a given armature current, and is adjustable from 0% to 100%, in 5% increments.

The Field Map parameter is set as a percentage of the field current between the Field Min and Field Max values. As shown in Figure 19, the Field Map parameter increases or decreases the field current at the armature current that is halfway between the Field Map Start current and the controller's programmed drive current limit. This point on the armature current curve is referred to as the Field Map Midpoint.

With the Field Map set at 50% and the Field Map Start set at zero, the motor's field current increases linearly with increasing armature current—thus emulating a series wound motor. Decreasing the field map setting reduces the field current at a given armature current, i.e., it weakens the field. As the field current is reduced, the motor will be able to maintain speeds closer to the maximum speed value.

Care should be taken to ensure that excessively low Field Map values do not move the motor's operating characteristics outside its safe commutation region. Recommendations for adjusting the Field Map parameter to achieve various performance characteristics are provided in Section 6: Vehicle Performance Adjustment Guidelines.

Fig. 19 *Field current relative to armature current, with field map parameter set at 50% and 20%.*

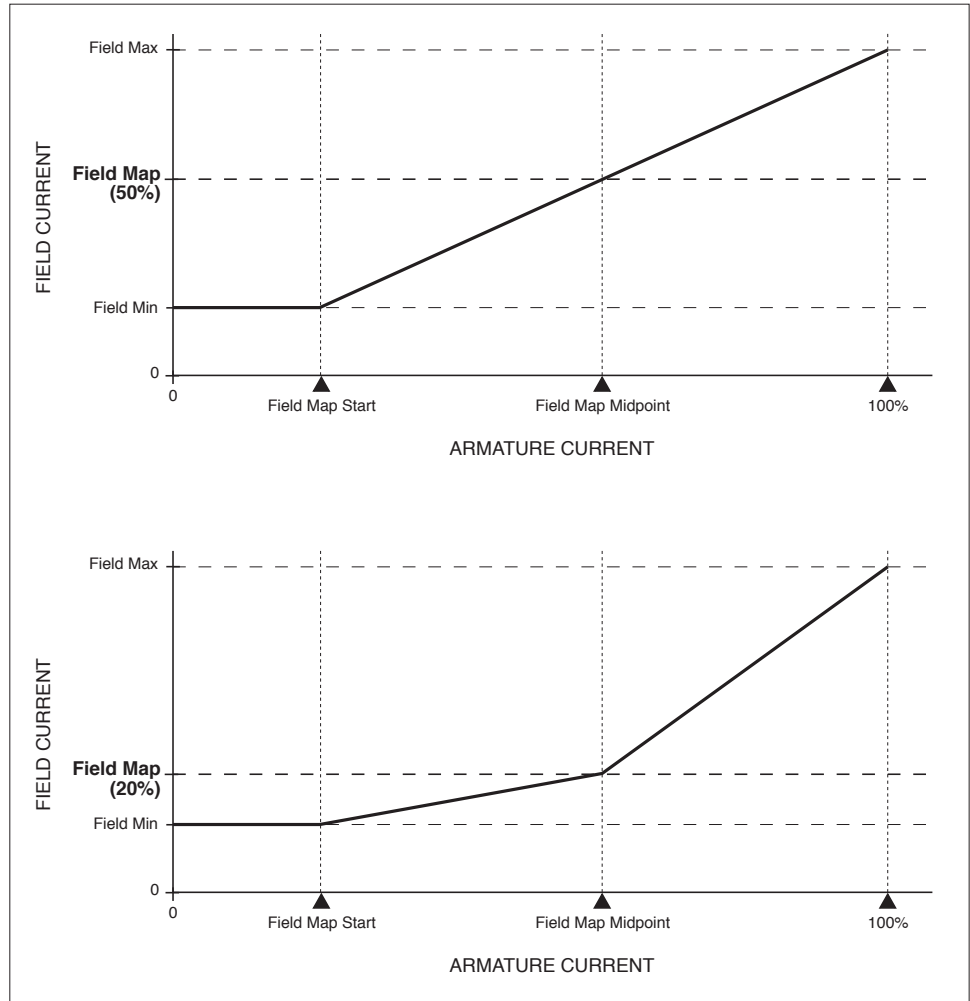

Fault Parameters

HPD

The **high pedal disable (HPD)** feature prevents the vehicle from driving the motor if greater than HPD Threshold throttle is applied when the controller is turned on. In addition to providing routine smooth starts, HPD also protects against accidental sudden starts if problems in the throttle linkage (e.g., bent parts, broken return spring) give a throttle input signal to the controller even with the throttle released.

If the operator attempts to start the vehicle with the throttle already applied, the controller will inhibit output to the motor until the throttle is reduced below HPD Threshold. For the vehicle to run, the controller must receive

a KSI input [*Type 1*],

a KSI input and an interlock input [*Type 2*], or

a KSI input, an interlock input, and a direction input [*Type 3*],

before receiving a throttle input. Either of these three types of HPD can be selected via the programmer. HPD can also be disabled [*Type 0*]. To meet EEC requirements, the HPD feature must be programmed to Type 1 or 2. To meet MSHA requirements, HPD must be programmed to Type 3.

Sequencing delay (see page 47) can be used to provide a variable delay before the controller is disabled, if desired.

No HPD (Type 0)

HPD function is disabled.

Interlock-type HPD (Type 1)

To start the vehicle, the controller must receive an interlock switch input in addition to a KSI input before receiving a throttle input. Controller operation will be disabled immediately if throttle input is greater than HPD Threshold at the time the interlock switch is closed. Normal controller operation is regained by reducing the throttle demand to less than HPD Threshold.

KSI-type HPD (Type 2)

To start the vehicle, the controller must receive a KSI input before receiving a throttle input. Controller operation will be disabled immediately if throttle input is greater than HPD Threshold at the time KSI is enabled. If throttle is applied before the interlock switch is closed but after the KSI input has been enabled, the vehicle will accelerate to the requested speed as soon as the interlock switch is closed. Normal operation is regained by reducing the throttle demand to less than HPD Threshold.

Golf-type HPD (Type 3)

To start the vehicle, the controller must receive a direction input in addition to an interlock switch input and a KSI input before receiving a throttle input. Controller operation will be disabled immediately if throttle input is greater

than HPD Threshold at the time the direction switch is closed or is changed while driving. Normal controller operation is regained by reducing the throttle demand to less than HPD Threshold.

HPD THRESHOLD

The **HPD threshold** parameter defines the maximum throttle allowed at startup. If throttle is greater than this threshold at startup, an HPD fault is issued. This parameter has a default setting of 25%, and is programmable from 0 to 25%.

SRO

The **static return to off (SRO)** feature prevents the vehicle from being started when “in gear.” SRO checks the sequencing of the interlock input—or the interlock input and KSI—relative to a direction input. The interlock input—or the interlock plus KSI inputs—must come on before a direction is selected. If a direction is selected before or simultaneously (within 50 msec) with the interlock input, the controller is disabled.

Three types of SRO are available (along with a “no SRO” option):

Type 0: no SRO

Type 1: SRO on interlock input plus a direction input

Type 2: SRO on KSI plus interlock input plus a direction input

Type 3: SRO on KSI plus interlock input plus forward direction input.

If your controller is programmed so that both KSI and interlock inputs are required (SRO Type “2”), the following sequence must be followed to enable the controller: STEP 1, turn on KSI; STEP 2, activate interlock (input “high”); and then STEP 3, select a direction. The interval between steps 1 and 2 is the same as between steps 2 and 3; that is, KSI input must precede interlock input by at least 50 msec. Once the controller is operational, turning off either KSI or the interlock causes the controller to turn off; re-enabling the controller requires the 3-step sequence.

Similarly, if your controller is programmed so that KSI, interlock, and forward inputs are all required (SRO Type “3”), they must be provided in that sequence in order to enable the controller. Note, however, that operation is allowed if a reverse input precedes the interlock input; this can be useful when operating a walkie on ramps.

Sequencing delay (see page 47) can be used to provide a variable delay before disabling the controller, if desired.

FAULT CODE

The 1244 controller’s fault code drivers allow faults to be displayed in either of two different formats: Fault Code format or Fault Category format.

With the **fault code** parameter specified “On,” the controller’s fault outputs will provide information in Fault Code format. With the fault code parameter specified “Off,” the controller’s fault outputs will provide information in Fault Category format.

In Fault Code format, the two fault lines operate independently. When a fault is present, the Fault 1 driver (Pin 5) provides a pulsed signal equivalent to the fault code flashed by the controller’s built-in Status LED. This signal can be used to drive an LED located on the display panel to provide the fault code information to an operator, or to any remote panel. The Fault 2 driver (Pin 6) pulls low (to B-) and remains on until the fault is cleared; it can also be used to drive a remote LED. When no faults are present, these outputs will both be open (off).

In Fault Category format, the two fault lines together define one of four fault categories. Table 4 describes the four fault categories, shows the state of the two outputs for each category, and lists the faults that might be present when each of the four fault category signals is transmitted.

FAULT CATEGORY	FAULT 1 OUTPUT (Pin 5)	FAULT 2 OUTPUT (Pin 6)	POSSIBLE EXISTING FAULTS
0	HIGH	HIGH	(no faults present, or controller not operational)
1	LOW	HIGH	HW Failsafe; M-, Current Sensor, or Motor Fault; Throttle Fault; Emergency Reverse Wiring Fault; Contactor or Output Driver Fault; Precharge Fault
2	HIGH	LOW	Low Battery Voltage; Overvoltage; Thermal Cutback
3	LOW	LOW	HPD; SRO; Anti-Tiedown

Output Driver Parameters

MAIN CONT INTR

The **main contactor driver interlock** parameter allows the manufacturer to define a dual switch requirement to operate the vehicle. When this parameter is set to “On,” the controller requires that both the KSI input (Pin 1) and the interlock input (Pin 2) be pulled high (to B+) before the controller will engage the main contactor. The main contactor will open after the interlock switch is opened and the sequencing and main open delays expire. If this parameter is set to “Off,” only the KSI input is required for the main contactor to be engaged.

MAIN OPEN DLY

The **main contactor dropout delay** parameter is applicable only if the main contactor driver interlock parameter has been set to “On.” The dropout delay

parameter can then be set to allow the main contactor to remain closed for a period of time after the interlock switch is opened. The delay time is programmable from zero to 40 seconds, in 1 second intervals. The delay is useful for preventing unnecessary cycling of the main contactor and for maintaining power to auxiliary functions, such as a steering pump motor, that may be used for a short time after the brake has been applied or the operator has gotten up from the seat.

MAIN CHECK

The **main coil open check** parameter defines whether the controller performs missing coil checks to ensure that the main contactor has closed properly. When this parameter is set to “On,” the controller senses the voltage at the main driver input (Pin 17) to confirm that the main contactor coil is properly connected, and also tests that the main contactor has indeed closed each time it is commanded to do so. If the criteria for either of these tests are not met, the controller will inhibit operation and issue a fault. Neither of these tests is performed if the main check parameter is set to “Off.”

WELD CHECK

The **main contactor weld check** parameter defines whether the controller tests the main contactor to ensure that it is not welded closed. If the weld check parameter is set to “On,” this check is performed when the keyswitch is first engaged and then each time the main contactor is commanded to open. This check is not performed if the parameter is set to “Off.”

AUX DELAY

The **auxiliary driver dropout delay** parameter can be set to allow the auxiliary driver to remain active for a period of time after the interlock switch is opened. The delay time is programmable from 0 to 10 seconds, in 0.1 second intervals.

NOTE: The auxiliary driver dropout delay parameter is applicable only if the accessory driver enable has been specified “On.” The accessory driver enable is a factory-set parameter, and is described in Section 4.

AUX CHECK

The **auxiliary coil open check** parameter defines whether the controller performs missing coil checks on the auxiliary driver output. When this parameter is set to “On,” the controller senses the voltage at the auxiliary driver output (Pin 18) to confirm that the auxiliary contactor coil is properly connected. If

the criteria for this test are not met, the controller will inhibit operation and issue a fault. This test is not performed if the aux check parameter is set to “Off.”

Note: The aux check parameter is applicable only if the accessory driver enable has been specified “On.” The accessory driver enable is a factory-set parameter, and is described in Section 4.

REV DRVR CHECK

The **reverse signal open check** parameter defines whether the controller performs missing load checks on the reverse signal driver output. When this parameter is set to “On,” the controller senses the voltage at the reverse signal driver output (Pin 19) to confirm that the reverse signal driver load is properly connected. If the criteria for this test are not met, the controller will inhibit operation and issue a fault. This test is not performed if the reverse signal open check parameter is set to “Off.”

Note: The reverse signal open check parameter is applicable only if the accessory driver enable has been specified “On.” The accessory driver enable is a factory-set parameter, and is described in Section 4.

EM BRAKE DELAY

The **electromagnetic brake delay** parameter is applicable only if the accessory driver enable has been specified “On.” The accessory driver enable is a factory-set parameter, and is described in Section 4.

The electromagnetic brake delay parameter can be set to delay engaging the electromagnetic brake for a specified period of time after the controller senses that braking has been completed and the vehicle has come to a stop. The delay time is programmable from 0 to 5 seconds, in 0.1 second intervals.

EM BRAKE CHECK

The **electromagnetic brake open check** parameter defines whether the controller performs missing coil checks on the electromagnetic brake driver output. When this parameter is set to “On,” the controller senses the voltage at the electromagnetic brake driver output (Pin 20) to confirm that the electromagnetic brake coil is properly connected. If the criteria for this test are not met, the controller will inhibit operation and issue a fault. This test is not performed if the electromagnetic brake open check parameter is set to “Off.”

Note: The electromagnetic brake open check parameter is applicable only if the accessory driver enable has been specified “On.” The accessory driver enable is a factory-set parameter, and is described in Section 4.

CONT HOLDING

The **contactor holding voltage** parameter defines the output duty cycle of the main, auxiliary, reverse, and electromagnetic brake drivers. This parameter is adjustable from 20% to 100% of the battery voltage, in 2% increments. It allows the OEM to reduce the average applied voltage so that a contactor coil or other load that is not rated for the full battery voltage can be used.

For example, contactor coils rated for 12V could be used with a 36V system if the contactor holding voltage parameter were set to 34%. The parameter can be set lower than the rated contactor coil voltage, as long as it is set high enough to hold the contactor closed under all shock and vibration conditions the vehicle will be subjected to. Low settings minimize the current required to power the coil, thereby reducing coil heating and increasing battery life. Recommended values for the contactor holding voltage parameter should be determined with specifications or advice from the contactor manufacturer.

This parameter affects all the driver outputs, so the loads on each driver must allow operation at the set holding voltage. In addition, the loads on each driver must be compatible with a PWM signal (if the parameter is set to a value less than 100%), as the output is pulse width modulated.

CONT PULL IN

The **contactor pull-in voltage** parameter sets the peak voltage applied to the loads connected to the main, auxiliary, reverse and electromagnetic brake drivers. Typically these loads are contactor coils. The pull-in parameter allows a high initial voltage to be supplied when the driver first turns on, to ensure contactor closure. After 0.1 second, the driver voltage drops to the value specified by the contactor holding voltage parameter. Recommended values for this parameter should be determined with specifications or advice from the contactor manufacturer. This parameter is adjustable from 20% to 100% of the nominal battery voltage, in 2% increments.

Other Parameters

VOLTAGE

The **battery voltage** parameter sets the overvoltage and undervoltage protection thresholds for the electronic system. This parameter determines when regen should be cut back to prevent damage to batteries and other electrical system components due to overvoltage. Similarly, the undervoltage threshold protects systems from operating at voltages below their design thresholds. This will ensure proper operation of all electronics whenever the vehicle is driven. The

battery voltage parameter can be set from 2 to 7, and should always be set to the system's nominal battery pack voltage:

SETTING	NOMINAL VOLTAGE	S.U.V.	U.V.	O.V.	S.O.V.
2	24V	14V	16V	28V	31V
3	36V	22V	23.8V	43V	46V
4	48V	24V	32V	55V	61V
5	60V	37V	39V	70V	76V
6	72V	46V	49V	85V	92V
7	80V	52V	57V	97V	105V

s.u.v = Severe Under Voltage (causes reset)

u.v = Under Voltage

o.v = Over Voltage

s.o.v = Severe Over Voltage (causes reset)

ANTI-TIEDOWN

The **anti-tiedown** feature prevents operators from taping or “tying down” the mode select switches in order to operate permanently in Mode 2 or Mode 4. On startup, when the interlock switch is first closed, the anti-tiedown feature checks which operational mode is selected. If the mode select switches are requesting Mode 2 or Mode 4, the controller will ignore the request and default to Mode 1 or Mode 3 respectively. The controller will remain in Mode 1 or Mode 3 until the Mode Select 1 switch is released and reactivated.

Anti-tiedown is primarily used in walkie applications. It can be programmed “On” or “Off.”

SEQUENCING DLY

The **sequencing delay** feature allows the interlock switch to be cycled within a set time (the sequencing delay), in order to prevent inadvertent activation of HPD or SRO. This feature is useful in applications where the interlock switch may bounce or be momentarily cycled during operation. The sequencing delay parameter can be set from 0 to 3 seconds, in increments of 0.1 second, with 0 corresponding to no delay.

PEDAL INTR

The **pedal interlock** parameter can be programmed as “On” or “Off.” When “On,” it requires that the pedal switch input (Pin 8) be active (pulled to B+) before the controller will supply power to the motor. This feature is useful in systems that use a seat or foot switch to guarantee operator presence for vehicle operation. Alternatively, a switch connected to the brake pedal can be configured

to open immediately so that motor drive is disabled and will not interfere with the mechanical braking function. In this arrangement, when the brake pedal is released the controller output accelerates through its programmed acceleration curve to the existing throttle request.

The controller does not require the pedal signal to engage the main contactor, and the main contactor will not cycle on and off when the pedal switch is opened and closed.

EMR REV ENABLE

The **emergency reverse enable** parameter enables or disables the emergency reverse function. When it is set to “On,” the controller will be prepared to implement the emergency reverse current limit for enhanced braking and the direction change to reverse when the emergency reverse input (Pin 7) is pulled high (to B+). When the emergency reverse enable parameter is set to “Off,” the controller will not respond to any input to Pin 7 and the emergency reverse current limit and emergency reverse check parameters will not be active.

EMR REV CHECK

The **emergency reverse check** parameter is applicable only when the emergency reverse feature is being used in the application. If emergency reverse is not being used, this parameter should be set to “Off.”

When enabled (programmed “On”), the emergency reverse check tests for continuity from the emergency reverse check output (Pin 22) to the emergency reverse input (Pin 7). Therefore, the emergency reverse wiring should be connected as closely as possible to the controller side of the emergency reverse switch, as shown in Figure 13. If the controller detects this open wire fault, it will disable its output until the wiring fault is fixed. The emergency reverse function will still be active when this fault exists.

NODE ADDR

The **node address** parameter determines which address the controller will respond to when used with a CAN Bus communications system. The address can be specified from 1 to 15. This parameter is valid only when the CAN Bus function has been specified for the controller; see Section 4.

PRECHARGE

The **precharge** parameter enables or disables the precharge function. When this parameter is set to “On,” the precharge function does not close the main contactor until the internal power capacitor bank charges to within 10% of the battery voltage. Charging is accomplished internally and an external precharge resistor is not required. If the capacitor voltage does not reach this threshold, a precharge fault is issued and the main contactor is never closed. This reduces inrush current stresses on the capacitor bank and provides protection against allowing full battery power to be engaged if there is a short in the output section. Setting the parameter to “Off” disables the precharge function. The precharge function is required for systems using 48V (or higher) battery packs.

LOAD COMP

The **load compensation** parameter actively adjusts the applied motor voltage as a function of motor load current. This results in more constant vehicle speeds over variations in load and in driving surface (ramps, etc.) without the vehicle operator having to constantly adjust the throttle position. This parameter will also help equalize loaded and unloaded vehicle speeds. Higher load compensation values will cause the controller to be more aggressive in attempting to maintain vehicle speed. However, too much load compensation can result in jerky vehicle starts and speed oscillation (“hunting”) when the vehicle is unloaded.

The load compensation parameter is adjustable from 0 to 25. Recommendations for adjusting this parameter are provided in Section 6: Vehicle Performance Adjustment.

4

OEM-SPECIFIED PARAMETERS (SET AT FACTORY)

In addition to the programmable parameters described in Section 3, there are three parameters that can be set at the factory per the OEM's specification:

- MultiMode™ Enable
- Accessory Driver Enable
- CAN Bus Enable

These parameters are not programmable with the 1313 handheld programmer or 1314 PC Programming Station. If a change is desired, the controller must be returned to an authorized Curtis facility for reconfiguration.

MULTIMODE™ ENABLE

A key feature of Curtis MultiMode™ controllers is their capability of being configured for optimized performance in four distinctly defined modes. However, should the OEM prefer to offer only a single mode of operation in a given application, the MultiMode™ feature can be disabled. Each of the 1244 controller's eight MultiMode™ parameters can be individually defined as MultiMode™ or single mode.

OEM specifies > On or Off **Default setting** > On

ACCESSORY DRIVER ENABLE

The 1244 controller provides three accessory drivers: an auxiliary driver (Pin 18), a reverse signal driver (Pin 19), and an electromagnetic brake driver (Pin 20).

The auxiliary driver (Pin 18) provides a connection to B- when KSI and the interlock (if enabled) are activated. The driver will release after the programmed auxiliary driver dropout delay when the interlock switch is turned off.

The reverse signal driver (Pin 19) provides a connection to B- whenever the vehicle is moving in reverse, regardless of whether it is driving or braking. When the vehicle is moving forward or is in neutral, the output remains open. The reverse signal driver provides a continuous connection to B- (or a 500Hz pulsed signal if the contactor holding voltage is set at less than 100%) but is not intended to pulse an audible alarm.

The electromagnetic brake driver (Pin 20) will engage (pull to B-) when the throttle is applied or when creep speed is greater than zero and a direction is selected. It will release, after the programmed electromagnetic driver delay, when the throttle is returned to neutral or when the vehicle has come to a stop. When the electromagnetic brake driver is used, the neutral braking parameter must be set to a value greater than zero.

When the accessory driver enable is specified “On,” these three drivers are enabled. If none of these drivers is required, the accessory driver enable parameter should be specified as “Off.”

Each accessory driver output is rated at 2 amperes and is monitored for open connection and overcurrent faults. An internal diode provides coil suppression through the coil return output (Pin 9). Wiring for the accessory drivers is shown in Figure 12, page 18.

When the accessory driver enable is specified “On,” it also enables various programmable parameters associated with the accessory drivers: the auxiliary driver dropout delay, the auxiliary coil open check, the reverse signal open check, the electromagnetic brake dropout delay, and the electromagnetic brake open check. For more information on these programmable parameters, see Section 3.

Any component can be controlled by any of the accessory outputs provided its current requirements do not exceed the driver’s 2 amp rating.

The three accessory drivers are enabled or disabled as a group; it is not possible, for example, to have the electromagnetic brake driver enabled and the auxiliary driver and reverse signal driver disabled.

OEM specifies ► On or Off **Default setting** ► On

CAN BUS ENABLE

When enabled, this parameter configures the 1244 controller for use with CAN-based control systems.

OEM specifies ► On or Off **Default setting** ► Off

5

INSTALLATION CHECKOUT

Before operating the vehicle, carefully complete the following checkout procedure. If you find a problem during the checkout, refer to the diagnostics and troubleshooting section (Section 8) for further information.

The installation checkout can be conducted with or without a 1313 hand-held programmer or 1314 PC Programmig Station. The checkout procedure is easier with a programmer. Otherwise, observe the Status LED (located in the controller's label area) for diagnostic codes. The codes are listed in Section 8.



Put the vehicle up on blocks to get the drive wheels up off the ground before beginning these tests.

Do not stand, or allow anyone else to stand, directly in front of or behind the vehicle during the checkout.

Make sure the keyswitch is off, the throttle is in neutral, and the forward and reverse switches are open.

Wear safety glasses and use well-insulated tools.

1. If a programmer is available, connect it to the programmer connector.
2. Turn the keyswitch on. The programmer should power up with an initial display, and the controller's Status LED should begin steadily blinking a single flash. If neither happens, check for continuity in the keyswitch circuit and controller ground.
3. If you are using a programmer, select the Diagnostics Menu, and open the Present Faults folder. The display should indicate "No Known Faults." Close the interlock switch (if one is used in your application). The Status LED should continue blinking a single flash and the programmer should continue to indicate no faults.

If there is a problem, the LED will flash a diagnostic code and the programmer will display a diagnostic message. If you are conducting the checkout without a programmer, look up the LED diagnostic code in Section 8 (Diagnostics and Troubleshooting).

When the problem has been corrected, it may be necessary to cycle the keyswitch in order to clear the fault.

4. With the interlock switch closed, select a direction and operate the throttle. The motor should begin to turn in the selected direction. If it turns in the wrong direction, first verify the wiring to the forward and reverse switches. If the wiring is correct, turn off the controller, disconnect the battery, and exchange the motor's field connections (**F1** and **F2**) on the controller. The motor should now turn in the proper direction. The motor should run proportionally faster with increasing throttle. If not, refer to Section 8.
5. If you are using a programmer, select the Monitor Menu. Scroll down to observe the status of the forward, reverse, interlock, emergency reverse, and mode switches. Cycle each switch in turn, observing the programmer. The programmer should display the correct status for each switch.
6. Take the vehicle down off the blocks and drive it in a clear area. It should have smooth acceleration and good top speed. Recommended procedures for tuning the vehicle's driving characteristics are presented in Section 6: Vehicle Performance Adjustment.
7. Test the deceleration and braking of the vehicle.
8. Verify that all options, such as high pedal disable (HPD), static return to off (SRO), and anti-tiedown are as desired.
9. On walkie vehicles, check the emergency reverse feature. If you have the optional emergency reverse check wiring, verify that the check circuit is operational by momentarily disconnecting one of the emergency reverse wires. The vehicle should coast to a stop, with a fault indicated.
10. If you used a programmer, disconnect it when you have completed the checkout procedure.

6

VEHICLE PERFORMANCE ADJUSTMENT

The 1244 controller is a very powerful vehicle control system. Its wide variety of adjustable parameters allow many aspects of vehicle performance to be optimized. This section provides explanations of what the major tuning parameters do and instructions on how to use these parameters to optimize the performance of your vehicle. Once a vehicle/motor/controller combination has been tuned, the parameter values can be made standard for that system or vehicle model. Any changes in the motor, the vehicle drive system, or the controller will require that the system be tuned again to provide optimum performance.

The tuning procedures should be conducted in the sequence given, because successive steps build upon the ones before. The tuning procedures instruct personnel how to adjust various programmable parameters to accomplish specific performance goals. It is important that the effect of these programmable parameters be understood in order to take full advantage of the 1244 controller's powerful features. Please refer to the descriptions of the applicable parameters in Section 3 if there is any question about what any of them do.

MAJOR TUNING

Four major performance characteristics are usually tuned on a new vehicle:

- ① Tuning the Active Throttle Range
- ② Tuning the Controller to the Motor
- ③ Setting the Unloaded Vehicle Top Speed
- ④ Equalization of Loaded/Unloaded Vehicle Speed.

These four characteristics should be tuned in the order listed.

① Tuning the Active Throttle Range

Before attempting to optimize any specific vehicle performance characteristics, it is important to ensure that the controller output is operating over its full range. To do this, the throttle should be tuned using the programmer. The procedures that follow will establish Throttle Deadband and Throttle Max parameter values that correspond to the absolute full range of your particular throttle mechanism. It is advisable to provide some buffer around the absolute full range of the throttle mechanism to allow for throttle resistance variations over time and temperature as well as variations in the tolerance of potentiometer values between individual throttle mechanisms.

①-A *Tuning the Throttle Deadband*

- STEP 1. Jack the vehicle wheels up off the ground so that they spin freely.
- STEP 2. Plug the programmer into the controller and turn on the key-switch and interlock switch (if used).
- STEP 3. When the programmer instructs you to select a menu, select the Monitor Menu. The Throttle % should be visible at the top of the display. You will need to reference the value displayed here.
- STEP 4. Scroll down until the Forward Input is visible. The display should indicate that the forward switch is Off.
- STEP 5. Slowly rotate the throttle forward until the display indicates that the forward switch is On. Use care with this step as it is important to identify the threshold throttle position at which the forward switch is engaged and the controller recognizes the forward command.
- STEP 6. Without moving the throttle, scroll up to display the Throttle % and read the value shown. This value should be zero. If the Throttle % value is zero, proceed to Step 7. If it is greater than zero, the Throttle Deadband parameter must be increased and the procedure repeated from Step 5 until the Throttle % is zero at the forward direction engagement point.
- STEP 7. While observing the Throttle % value in the programmer's Monitor Menu, continue to rotate the throttle past the forward switch engagement point. Note where the Throttle % value begins to increase, indicating that the controller has begun to supply drive power to the motor. If the throttle had to be rotated further than desired before the Throttle % value began to increase, the Throttle Deadband parameter value must be decreased and the procedure repeated from Step 5. If the amount of rotation between the point at which the Forward switch is engaged and the Throttle % value begins to increase is acceptable, the Throttle Deadband is properly tuned.
- STEP 8. If a bidirectional (wigwag) throttle assembly is being used, the procedure should be repeated for the reverse direction. The Throttle Deadband value should be selected such that the throttle operates correctly in both forward and reverse.

①-B *Tuning the Throttle Max*

- STEP 1. Jack the vehicle wheels up off the ground so that they spin freely.
- STEP 2. Plug the 1313 programmer into the controller and turn on the keyswitch and interlock switch (if used).
- STEP 3. When the programmer instructs you to select a menu, select the Monitor Menu. The Throttle % should be visible at the top of the display. You will need to reference the value displayed here.
- STEP 4. Rotate the throttle forward to its maximum speed position and observe the Throttle % value. This value should be 100%. If it is less than 100%, the Throttle Max parameter value must be decreased to attain full controller output at the maximum throttle position. Use the programmer to decrease the Throttle Max parameter value, and repeat this step until the value is 100%.
- STEP 5. Now that the full throttle position results in a 100% value for Throttle %, slowly reduce throttle until the Throttle % value drops below 100% and note the throttle position. This represents the extra range of motion allowed by the throttle mechanism. If this range is large, you may wish to decrease it by increasing the Throttle Max parameter value. This will provide a larger active throttle range and more vehicle control. Using the programmer, increase the Throttle Max parameter value and repeat the test until an appropriate amount of extra range is attained.
- STEP 6. If a bidirectional (wigwag) throttle assembly is being used, repeat the procedure for the reverse direction. The Throttle Max value should be selected such that the throttle operates correctly in both forward and reverse.

② Tuning the Controller to the Motor

The 1244 controller has the flexibility to be tuned to nearly any separately excited motor from any manufacturer. Parameters in the programmer's Parameters Menu allow full control of the motor's maximum armature current during driving and braking and full control of the motor's maximum and minimum field current as well as the field current relationship to the armature current. This flexibility allows motor performance to be maximized while protecting it from operating outside its safe commutation region.

In order to properly tune the controller, the following information should be obtained from the motor manufacturer:

- Maximum Armature Current Rating
- Maximum Field Current Rating
- Minimum Field Current Rating
- Field Resistance, hot and cold.

The performance of a separately excited motor changes depending on temperature. This is due to the change in field winding resistance as the motor heats up through use. When the field winding temperature increases, so does its resistance and therefore the maximum current that can be forced through the winding is reduced. Reductions in the field current over the motor's typical operating temperature range can be 10% to 50%. Since the maximum available field current determines the maximum torque that can be produced by the motor, the vehicle's performance under load and up inclines will change as the motor heats up. The change in performance can be limited by tuning the motor when it is hot rather than cold. Therefore, it is recommended that the following procedure be performed with a hot motor.

- STEP 1. Using the programmer's Parameters Menu, set the Drive Current Limit parameter value in each mode to the smaller of: (a) the motor's peak armature current rating, or (b) the maximum controller drive current limit. This value can later be adjusted to establish the desired vehicle driving feel in each mode.
- STEP 2. Set the Braking Current Limit parameter value in each mode to the smaller of: (a) the maximum motor armature current rating, or (b) the maximum controller braking current limit. This value can later be adjusted to establish the desired vehicle braking feel in each mode.
- STEP 3. To set the Field Max parameter value, first decide whether you want to maintain consistent vehicle operation throughout the motor's temperature range. If you do, proceed to Step 4. If, however, maintaining operational consistency across motor temperature is not a concern, but achieving maximum torque is, proceed to Step 5.

- STEP 4. For the most consistent operation across temperature, set the Field Max parameter to the maximum field current available at low battery voltage with a hot motor. To determine this current, divide the low battery voltage (typically 70% of nominal) by the high temperature field winding resistance specification provided by the manufacturer. Set the Field Max parameter to this value. This will provide good consistency between motor performance in both hot and cold states.
- STEP 5. For the maximum torque regardless of temperature, set the Field Max parameter to the motor's rated absolute maximum field current. To determine the absolute maximum field current, divide the nominal battery voltage by the low temperature field winding resistance specification provided by the manufacturer. Set the Field Max parameter to this value. This will provide the maximum possible torque under all conditions.

This has now set the Max Field parameter. The next step is to set the Min Field parameter. **NOTE: The Field Min parameter should never be set below the rated value specified by the manufacturer.** Operating the motor at lower field currents than specified will result in operation outside the motor's safe commutation region and will cause arcing between the brushes and commutator significantly reducing motor and brush life. The Field Min parameter value can be increased from the manufacturer's specified value to limit the vehicle's top speed. (Setting the vehicle top speed will be addressed later in this section.)

If the controller is tuned such that the system is operating outside the motor's safe commutation region, there will be audible and visual indications. Under normal operation, the motor will emit a whine with a pitch that increases with increasing rotation speed. If a "scratchy" sound is also heard, this is usually an indication that pin arcing is occurring in the motor and it is operating outside its safe commutation region. This operation is normally accompanied by a strong smell from the motor. If the brushes and commutator bars are visible, arcing may be visible. The further outside the safe commutation region the motor is operating, the worse the arcing will be. **Operation outside the safe commutation region is very detrimental to the motor.** The Field Min and possibly also the Field Map parameter should be increased until the indications of arcing stop. Decreasing the Field Map Start parameter will also help to move operation back into the safe commutation region.

③ Setting the Unloaded Vehicle Top Speed

The controller and vehicle should be configured as follows prior to setting the maximum unloaded vehicle speed:

- Max Speed = 100%, all modes
- Drive Current Limit as established in tuning procedure ②
- Field Map = 50%
- Field Map Start = 50% of the specified drive current limit
- Field Min = manufacturer's specified minimum or 3 amperes
- Load Comp = 0
- The vehicle should be unloaded
- The vehicle battery should be fully charged.

The vehicle should be driven on a flat surface in a clear area during this procedure. Since the vehicle may initially be traveling at speeds in excess of the final intended speed, precautions should be taken to ensure safety of test personnel and anyone in the test area.

- STEP 1. Select the programmer's Program Menu and scroll down until the Field Min parameter is at the top of the display.
- STEP 2. Power up the vehicle and apply full throttle. While driving the vehicle with full throttle applied, adjust the Field Min parameter value to set the desired top speed. Increasing the Field Min value decreases the vehicle's top speed; decreasing the Field Min value increases the vehicle's top speed. **CAUTION:** Do not decrease the Field Min parameter value below the motor manufacturer's recommended minimum field current value, and do not increase it above 10 amps. **NOTE:** If the Field Min value is too low, the vehicle speed may oscillate or surge even at constant throttle. If oscillation or surge is observed, increase the Field Min value until the vehicle speed remains constant at constant throttle.
- STEP 3. If the Field Min parameter value is increased to 10 amps and the vehicle top speed has still not been sufficiently reduced, the Max Speed parameter should be used to bring the vehicle top speed down to the desired level. First, decrease the Field Min parameter, setting it to optimize smooth starting. Then adjust the Max Speed parameter per Step 4 to bring the vehicle top speed down to the desired level. **NOTE:** If the Field Min parameter is set too high, the high initial torque created by the high field current may cause overly abrupt starts; this is why we recommend using the Max Speed parameter in those cases where a moderate Field Min setting does not sufficiently reduce the vehicle top speed.

- STEP 4. Scroll up the Program Menu until the Max Speed parameter is at the top of the display. While driving the vehicle with the Field Min set at the value selected in Step 3, decrease the Max Speed parameter value until the desired vehicle top speed is set.
- STEP 5. *For Walkie/Rider Applications:* Typically, different top speeds are desired for walkie and rider operation. To tune a walkie/rider vehicle's top speed, first tune it for rider operation. Use the Field Min parameter to tune the vehicle top speed. Then, to set the top speed for walkie operation, leave the Field Min parameter unchanged and decrease the Max Speed parameter until the desired walking speed is reached.

④ Equalization of Loaded and Unloaded Vehicle Speed

The top speed of a loaded vehicle can be set to approach the unloaded top speed by tuning the 1244 controller's Field Map Start and Load Compensation parameters. It is recommended that you review the description of the Field Map Start parameter (page 38) and Load Compensation parameter (page 49) before starting this procedure.

- STEP 1. The vehicle's unloaded top speed should already have been set. If it was not, it should be set before the vehicle's loaded top speed is established.
- STEP 2. Once the vehicle's unloaded top speed has been set, load the vehicle to the desired load capacity. Leave the Field Min and Speed Max parameters at the settings determined during the unloaded test.
- STEP 3A. If the intent is to minimize the difference between the loaded and unloaded vehicle speeds, then:
- (i) Drive the fully loaded vehicle on flat ground with full throttle applied. When the vehicle reaches maximum speed, observe the armature current displayed in the programmer's Test Menu.
 - (ii) Set the Field Map Start parameter slightly higher than the observed armature current value.
 - (iii) Test the loaded/unloaded speed variation. If it is unacceptable, proceed to (iv).
 - (iv) Increase the Load Compensation parameter and retest the speed regulation. The Load Compensation parameter can be increased until the desired regulation is achieved or the vehicle speed begins to oscillate ("hunt") at low throttle.

- STEP 3B. If the intent is to make the loaded speed less than the unloaded speed (for reasons of safety, efficiency, or reduced motor heating), then:
- (i) Unload the vehicle and drive it on flat ground with full throttle applied. When the vehicle reaches maximum speed, observe the armature current displayed in the programmer's Test Menu.
 - (ii) Set the Field Map Start parameter to the observed armature current value.
 - (iii) Load the vehicle and drive it on flat ground with full throttle applied. Further adjustments to the vehicle's loaded speed can now be made by varying the Field Map parameter. Increasing the Field Map parameter value will decrease the vehicle's loaded speed, and decreasing the Field Map parameter value will increase the vehicle's loaded speed.

CAUTION: If the Field Map Start parameter is set too high, the motor's safe commutation region may be exceeded. If this is the case, reduce the Field Map Start parameter to a safe value. Then, adjust the Field Map parameter as needed to reach the desired loaded top speed. Reducing the Field Map parameter will help bring the loaded speed closer to the unloaded speed. However, care must still be taken because it is possible for too low Field Map values—like too high Field Map Start values—to result in operation outside the motor's safe commutation region.

FINE TUNING

Four additional vehicle performance characteristics can be adjusted:

- ⑤ Response to Increased Throttle
- ⑥ Response to Reduced Throttle
- ⑦ Smoothness of Direction Transitions
- ⑧ Ramp Climbing
- ⑨ Ramp Restraint.

These characteristics are related to the “feel” of the vehicle and will be different for various applications. Once the fine tuning has been accomplished, it should not have to be repeated on every vehicle.

⑤ Response to Increased Throttle

The vehicle’s response to quick or slow throttle increases can be modified using the Accel Rate, Current Ratio, Quick Start, and Throttle Map parameters. Optimal vehicle response is tuned by adjusting these parameters and then accelerating the vehicle from a dead stop under various throttle transition conditions.

- STEP 1. Set Quick Start = 0 and Throttle Map as desired.
- STEP 2. Drive the vehicle and adjust the Accel Rate for the best overall acceleration response. If the vehicle starts too slowly under all driving conditions, the Accel Rate should be reduced.
- STEP 3. Increasing vehicle acceleration. If acceleration feels good for slow or moderate throttle transitions but the vehicle initially starts too slowly, set the Current Ratio to 2 or higher. If acceleration is not satisfactory when the throttle is transitioned quickly from zero to full speed, increase the Quick Start parameter value to obtain the desired fast throttle response.
- STEP 4. Achieving better control at low speeds. If the vehicle responds well for fast, full range throttle transitions but is too jumpy during low speed maneuvering, reduce the Quick Start, reduce the Throttle Map, and/or set the Current Ratio = 1. If these adjustments are insufficient or unacceptable, you may want to define a separate operational mode for precision maneuvering. The Accel Rate, Max Speed, and Drive Current Limit parameters can be tuned exclusively for this precision-maneuvering mode to obtain comfortable vehicle response.

⑥ Response to Reduced Throttle

The way the vehicle responds when the throttle is reduced or completely released can be modified using the Decel Rate, Throttle Braking %, and Restraint parameters. This response is particularly noticeable when the vehicle is traveling downhill.

- STEP 1. Set the Decel Rate and Throttle Braking % parameters based on the desired time for the vehicle to stop upon release of throttle when traveling at full speed with full load. If the vehicle brakes too abruptly when the throttle is released, increase the Decel Rate and/or decrease the Throttle Braking %.
- STEP 2. The default Restraint setting should work well for most vehicles. If the vehicle exhibits excessive overspeed when driving down a ramp, increase the Restraint value. If the vehicle “speed hunts” while driving down a ramp or brakes too abruptly at small reductions in throttle, decrease the Restraint value.
- STEP 3. If the Restraint value has been adjusted, retest braking behavior when throttle is reduced to ensure that it still has the desired feel. If it does not, the Decel Rate and/or Throttle Braking % should be re-adjusted as in Step 1.

⑦ Smoothness of Direction Transitions

After the major performance and responsiveness tuning has been completed, additional fine tuning can be performed in the vehicle’s transitions between braking and driving. These transitions are affected by the Taper Rate, Accel Rate, Braking Rate, and Braking Current Limit parameters.

⑦-A *Drive-to-Brake Transitions*

- STEP 1. If the transition is too slow: decrease the Braking Rate parameter value for faster braking.
- STEP 2. If the transition is too abrupt: increase the Braking Rate parameter value for slower braking.
- STEP 3. If the braking distance is too long: increase the Braking Current Limit parameter value or decrease the Braking Rate parameter value.
- STEP 4. If the applied braking torque is too high: reduce the Braking Current Limit parameter value. Reducing the braking current will also reduce motor heating, improve brush life, and improve the forward-to-reverse transition feel. NOTE: If the braking current limit is changed, evaluation and adjustment of the Throttle Braking % parameter may be necessary to obtain the response originally set in procedure ⑥.

⑦-B Forward-to-Reverse Transitions

- STEP 1. Begin this test set with the Taper Rate parameter set to 64. Drive the vehicle and transition directly from forward to reverse. A slight pause should be noticeable at the zero speed point. Reduce the Taper Rate parameter value until the pause is eliminated. Reducing the Taper Rate value further may cause a slight bump during the direction transition.
- STEP 2. If the transition is slow or the vehicle feels sluggish: reduce the Accel Rate parameter value.
- STEP 3. If the vehicle exhibits a small bump at zero speed: increase the Taper Rate parameter value.

⑦-C Low Speed vs. High Speed Braking

The 1244 controller is capable of both regenerative and plug braking, and can be programmed to use one or the other as a function of vehicle speed. Plug braking provides quicker response and direction transition at low speeds, while regen braking is more powerful and efficient at high speeds. The Regen Speed parameter is used to define the threshold vehicle speed at which the type of braking changes from one to the other.

To determine the ideal Regen Speed parameter for your application, jockey the vehicle back and forth from forward to reverse at low speeds. Increase the Regen Speed parameter value until the vehicle feels more responsive during the direction changes. Then drive the vehicle at high speed and test the braking. If the braking feels weak, reduce the Regen Speed parameter value.

The Regen Speed parameter can be adjusted from 0% to 100% of the vehicle speed. In other words, the point at which the controller enables regen braking can be set anywhere within the vehicle's entire speed range. However, setting the Regen Speed parameter to a high percentage of the maximum vehicle speed will result in weak braking at high speeds along with increased motor heating. Additionally, no energy will be returned to the batteries to extend the total charge time and the motor brush wear will be higher than if regen braking is used. Typical Regen Speed values are between 10% and 60% of the maximum vehicle speed.

⑧ Ramp Climbing

The vehicle response to increased gradients such as loading ramps can be tuned via the Field Map parameter. Decreasing the Field Map parameter allows faster vehicle speeds while climbing ramps, but it will also have the effect of reducing the ability of the controller to generate torque in the vehicle's mid range speeds.

- STEP 1. If faster vehicle speed is desired when climbing ramps, decrease the Field Map parameter value until the desired ramp climbing speed is attained. It should be noted that if the motor's torque capability is exceeded under the conditions of load and ramp gradient, vehicle speed will be limited by the motor's capability and the desired vehicle speed may not be attainable. The system will find a compromise point at which sufficient motor torque is generated to climb the ramp at an acceptable speed. If the Field Map parameter value is reduced to 0% and the desired speed is still not attained, the system is being limited by the motor's torque capability under these operating conditions. Caution should be used in reducing the Field Map parameter since at low Field Map values it is possible that the motor could be operated outside its safe commutation region.
- STEP 2. If the drive system cannot produce sufficient torque for a fully loaded vehicle to climb the desired ramp, try increasing the Field Map, Field Max, and/or Drive Current Limit parameters. The impact of increasing these parameter values on other driving characteristics must be evaluated. Increasing the Field Max will provide more field current, and increasing the Drive Current Limit will provide more armature current. If the Field Max is set at the manufacturer's specified limit and the Drive Current Limit is set at the rated maximum, then vehicle speed up the ramp is limited by the motor or the vehicle's gearing and cannot be increased by tuning the controller. NOTE: To determine if the controller's armature current is at its set value during ramp climbing, read the "Arm Current" in the programmer's Test Menu.

⑨ Ramp Restraint

The Restraint parameter can be used to limit vehicle movement after the vehicle has come to a stop. If the vehicle brakes to a stop on an incline and the brake has not engaged, the Restraint function will limit the rate at which the vehicle travels down the incline. Higher values of Restraint will result in slower vehicle creeping down the incline. The Restraint function can never hold a vehicle perfectly stationary on an incline and is not intended to replace a mechanical or electromagnetic brake for this purpose. However, it will prevent uncontrolled vehicle coasting in this situation.

The Restraint parameter also influences the vehicle's response to reduced throttle. If the Restraint parameter is set to a high value in order to slow the vehicle's downhill creeping when it is stopped on an incline, this high Restraint setting will also affect the vehicle's response to reduced throttle. Therefore, the Restraint parameter should be set with both situations in mind. For tuning the vehicle's response to reduced throttle, see tuning procedure ⑥, page 63.

7

PROGRAMMER MENUS

Items are listed for each menu in the order in which they are displayed on the programmer.

Parameters Menu (not all items available on all controllers)

VOLTAGE	Nominal battery voltage, in volts
M1 DRIVE C/L	Mode 1 drive current limit, in amps
M2 DRIVE C/L	Mode 2 drive current limit, in amps
M3 DRIVE C/L	Mode 3 drive current limit, in amps
M4 DRIVE C/L	Mode 4 drive current limit, in amps
M1 BRAKE C/L	Mode 1 braking current limit, in amps
M2 BRAKE C/L	Mode 2 braking current limit, in amps
M3 BRAKE C/L	Mode 3 braking current limit, in amps
M4 BRAKE C/L	Mode 4 braking current limit, in amps
M1 THRT BRK %	Mode 1 throttle braking, as % of brake C/L
M2 THRT BRK %	Mode 2 throttle braking, as % of brake C/L
M3 THRT BRK %	Mode 3 throttle braking, as % of brake C/L
M4 THRT BRK %	Mode 4 throttle braking, as % of brake C/L
M1 ACCEL RATE	Mode 1 acceleration rate, in seconds
M2 ACCEL RATE	Mode 2 acceleration rate, in seconds
M3 ACCEL RATE	Mode 3 acceleration rate, in seconds
M4 ACCEL RATE	Mode 4 acceleration rate, in seconds
DECEL RATE	Deceleration rate, in seconds
M1 BRAKE RATE	Mode 1 braking rate, in seconds
M2 BRAKE RATE	Mode 2 braking rate, in seconds
M3 BRAKE RATE	Mode 3 braking rate, in seconds
M4 BRAKE RATE	Mode 4 braking rate, in seconds
QUICK START	Quick-start throttle factor
TAPER RATE	Regen braking decrease rate when approaching zero speed, in 1/32 s
M1 MAX SPEED	Mode 1 maximum speed, as % PWM output
M2 MAX SPEED	Mode 2 maximum speed, as % PWM output
M3 MAX SPEED	Mode 3 maximum speed, as % PWM output
M4 MAX SPEED	Mode 4 maximum speed, as % PWM output
M1 CREEP SPEED	Mode 1 creep speed, as % PWM output
M2 CREEP SPEED	Mode 2 creep speed, as % PWM output
M3 CREEP SPEED	Mode 3 creep speed, as % PWM output
M4 CREEP SPEED	Mode 4 creep speed, as % PWM output
REGEN SPEED	Minimum speed for regen braking, as % of vehicle speed
CTRL MODE	Control mode ¹
THROTTLE TYPE	Throttle type ²
THRTL DEADBAND	Throttle neutral deadband, as % of 5k Ω pot
THROTTLE MAX	Throttle input req'd for 100% PWM, as % of 5k Ω pot

Parameters Menu, cont'd

M1 THRTL MAP	Mode 1 throttle map, as %
M2 THRTL MAP	Mode 2 throttle map, as %
M3 THRTL MAP	Mode 3 throttle map, as %
M4 THRTL MAP	Mode 4 throttle map, as %
FIELD MIN	Minimum field current, in amps
FIELD MAX	Maximum field current, in amps
HPD THRESHOLD	Allowable throttle at startup, as % active throttle range
FLD MAP START	Armature current at which field map takes effect, in amps
FIELD MAP	Field winding current, as % armature current
CURRENT RATIO	Current ratio: factor of 1, 2, 4, or 8
RESTRAINT	Ramp restraint: 1 to 10
LOAD COMP	Load compensation: 0 to 25
HPD	High pedal disable (HPD) type ³
SRO	Static return to off (SRO) type ⁴
SEQUENCING DLY	Sequencing delay, in seconds
MAIN CONT INTR	Main contactor interlock: On or Off
MAIN OPEN DLY	Main contactor dropout delay, in seconds
WELD CHECK	Main contactor weld check: On or Off
MAIN CHECK	Main coil open check: On or Off
AUX DELAY	Auxiliary driver dropout delay, in seconds
AUX CHECK	Auxiliary coil open check: On or Off
EM BRAKE DELAY	Electromagnetic brake delay, in seconds
EM BRAKE CHECK	Electromagnetic brake open check: On or Off
REV DRVR CHECK	Reverse signal open check: On or Off
CONT PULL IN	Contacting coil pull-in voltage, as %
CONT HOLDING	Contacting coil holding voltage, as %
EMR REV ENABLE	Emergency reverse function: On or Off
EMR REV C/L	Emergency reverse current limit, in amps
EMR REV CHECK	Emergency reverse wiring check: On or Off
ANTI-TIEDOWN	Anti-tiedown: On or Off
FAULT CODE	Fault output type ⁵
PEDAL INTRLCK	Pedal switch interlock: On or Off
PRECHARGE	Precharge function: On or Off
NODE ADDR	CAN-Bus address: 1 through 15

Parameters Menu Notes

¹ Control modes (for detail, see Section 3: Programmable Parameters, page 28)

Type 0: Current control mode—throttle controls motor torque

Type 1: Voltage control mode—throttle controls motor speed

² Throttle types (for detail, see Throttle Wiring in Section 2)

Type 1: 5k Ω –0

Type 2: single-ended 0–5V, 3-wire pot, current source, and electronic throttles

Type 3: 0–5k Ω

Type 4: wigwag 0–5V and 3-wire pot

Type 5: CAN-Nodes type throttles

³ HPD types (for detail, see Section 3: Programmable Parameters, page 41)

Type 0: no HPD

Type 1: HPD unless KSI and interlock inputs received before throttle request

Type 2: HPD unless KSI input is received before throttle request

Type 3: HPD unless KSI and interlock and direction inputs received before throttle request

⁴ SRO types (for detail, see Section 3: Programmable Parameters, page 42)

Type 0: no SRO

Type 1: SRO unless interlock input is received before a direction is selected

Type 2: SRO unless KSI + interlock inputs received before direction selected

Type 3: SRO unless KSI + interlock + forward inputs received in that order

⁵ Fault output types (for detail, see Section 3: Programmable Parameters, page 43)

On: Fault Code format

Off: Fault Category format

Monitor Menu (not all items available on all controllers)

THROTTLE %	Throttle reading, as % of full throttle
ARM CURRENT	Motor armature current, in amps
FIELD CURRENT	Motor field current, in amps
ARM PWM	Motor armature appl'd duty cycle, as %
FIELD PWM	Motor field applied duty cycle, as %
BATT VOLTAGE	Voltage at KSI
CAP VOLTAGE	Voltage at controller's B+ bus bar
HEATSINK TEMP	Heatsink temperature, in °C
FORWARD INPUT	Forward switch: on/off
REVERSE INPUT	Reverse switch: on/off
MODE	Controller operating mode: 1 to 4
INTRLCK INPUT	Interlock switch: on/off
PEDAL INPUT	Pedal switch: on/off
EMR REV INPUT	Emergency reverse switch: on/off
MOTOR RPM	Tachometer input: pulses per second
MAIN CONT	Main contactor: open/closed
AUX CONT	Auxiliary driver: open/closed
REV OUTPUT	Reverse driver status: on(low)/off(high)
BRAKE OUTPUT	Brake driver status: on(low)/off(high)
FAULT 1 OUTPUT	Fault 1 driver status: on(low)/off(high)
FAULT 2 OUTPUT	Fault 2 driver status: on(low)/off(high)
CONTROL STATE	Controller's functional state: 0 to 13*
MODSEL 1	Mode Select 1 switch: on/off
MODSEL 2	Mode Select 2 switch: on/off

* Control states are used for diagnostic and troubleshooting purposes.

Diagnostics “Menu”

This is not a menu as such, but simply a list of the possible messages you may see displayed when you select the Diagnostics Menu. The messages are listed in alphabetical order for easy reference.

ANTI-TIEDOWN	Mode 2 or 4 selected at startup
ARM SENSOR	Armature sensor fault
BB WIRING CHECK	Emergency reverse wiring check failed
CONT DRVR OC	Contactor driver overcurrent
FIELD OPEN	Field winding open or disconnected
FLD SENSOR	Field sensor fault
HPD	High pedal disable (HPD) activated
HW FAILSAFE 1	Power-on self test fault
HW FAILSAFE 2	External watchdog fault
HW FAILSAFE 3	Internal watchdog fault
LOW BATTERY VOLTAGE	Battery voltage too low
M- SHORTED	M- output shorted to B-
MAIN CONT DNC	Main contactor did not close
MAIN CONT WELDED	Main contactor welded
MISSING CONTACTOR	Missing contactor
NO KNOWN FAULTS	No known faults
OVERVOLTAGE	Battery voltage too high
PRECHARGE FAULT	Precharge fault
SRO	Static return to off (SRO) activated
THERMAL CUTBACK	Cutback, due to over/under temperature
THROTTLE FAULT 1	Throttle out of range
THROTTLE FAULT 2	Throttle low fault

Other Menus

The System Info Menu shows information uploaded from your 1244 controller: model number, serial number, etc. The HHP Settings Menu allows you to select the 1313 handheld programmer’s display language, adjust its display contrast, etc. The Program Menu allows you to save and restore parameter settings files.

8

DIAGNOSTICS AND TROUBLESHOOTING

The 1244 controller provides diagnostics information to assist technicians in troubleshooting drive system problems. The diagnostics information can be obtained by observing the appropriate display on the 1313 handheld programmer or 1314 PC Programming Station, the fault codes issued by the Status LED, or the fault display driven by the controller's Fault 1 and Fault 2 outputs. Refer to the troubleshooting chart (Table 5) for suggestions covering a wide range of possible faults.

PROGRAMMER DIAGNOSTICS

The programmer presents complete diagnostic information in plain language. Faults are displayed in the Diagnostics Menu (see column 2 in the troubleshooting chart), and the status of the controller inputs/outputs is displayed in the Monitor Menu.

Accessing the Diagnostic History Menu provides a list of the faults that have occurred since the diagnostic history file was last cleared. Checking (and clearing) the diagnostic history file is recommended each time the vehicle is brought in for maintenance.

The following 4-step process is recommended for diagnosing and troubleshooting an inoperative vehicle: (1) visually inspect the vehicle for obvious problems; (2) diagnose the problem, using the programmer; (3) test the circuitry with the programmer; and (4) correct the problem. Repeat the last three steps as necessary until the vehicle is operational.

Example: A vehicle that does not operate in "forward" is brought in for repair.

STEP 1: Examine the vehicle and its wiring for any obvious problems, such as broken wires or loose connections.

STEP 2: Connect the programmer, select the Diagnostics Menu, and read the displayed fault information. In this example, the display shows "No Known Faults," indicating that the controller has not detected anything out of the norm.

STEP 3: Select the Test Menu, and observe the status of the inputs and outputs in the forward direction. In this example, the display shows that the forward switch did not close when "forward" was selected, which means the problem is either in the forward switch or the switch wiring.

STEP 4: Check or replace the forward switch and wiring and repeat the test. If the programmer shows the forward switch closing and the vehicle now drives normally, the problem has been corrected.

Table 5 TROUBLESHOOTING CHART







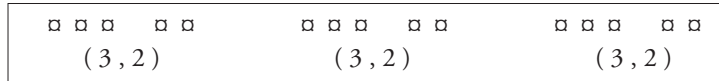





























LED CODE	PROGRAMMER LCD DISPLAY	FAULT CATEGORY	EXPLANATION	POSSIBLE CAUSE
1,2	HW FAILSAFE1-2-3	1	self-test or watchdog fault	1. Controller defective.
1,3	M- SHORTED	1	internal M- short to B-	1. Controller defective.
	FIELD OPEN	1	field winding fault	1. Motor field wiring loose. 2. Motor field winding open.
	ARM SENSOR	1	armature current sensor fault	1. Controller defective.
	FLD SENSOR	1	field current sensor fault	1. Controller defective.
2,1	THROTTLE FAULT 1	1	wiper signal out of range	1. Throttle input wire open. 2. Throttle input wire shorted to B+ or B-.
	THROTTLE FAULT 2	1	pot low fault	1. Throttle pot defective. 2. Wrong throttle type selected.
2,2	SRO	3	SRO fault	1. Improper sequence of KSI, interlock, and direction inputs. 2. Wrong SRO type selected. 3. Interlock or direction switch circuit open. 4. Sequencing delay too short.
2,3	HPD	3	HPD fault	1. Improper seq. of direction and throttle inputs. 2. Wrong HPD type selected. 3. Misadjusted throttle pot. 4. Sequencing delay too short. 5. HPD threshold set too low.
2,4	BB WIRING CHECK	1	emergency reverse wiring fault	1. Emergency reverse wire open. 2. Emergency reverse check wire open.
3,1	CONT DRVR OC	1	cont. driver output overcurrent	1. Contactor coil shorted.
3,2	MAIN CONT WELDED	1	welded main contactor	1. Main contactor stuck closed. 2. Main contactor driver shorted.
3,3	PRECHARGE FAULT	1	internal voltage too low at startup	1. Controller defective. 2. External short, or leakage path to B- on external B+ connection.
3,4	MISSING CONTACTOR	1	missing contactor	1. Any contactor coil open or not connected.
	MAIN CONT DNC	1	main contactor did not close	1. Main contactor missing or wire to coil open.
4,1	LOW BATTERY VOLTAGE	2	low battery voltage	1. Battery voltage <undervoltage cutback limit. 2. Corroded battery terminal. 3. Loose battery or controller terminal.
4,2	OVERVOLTAGE	2	overvoltage	1. Battery voltage >overvoltage shutdown limit. 2. Vehicle operating with charger attached. 3. Battery disconnected during regen braking.
4,3	THERMAL CUTBACK	2	over-/under-temperature cutback	1. Temperature >85°C or <-25°C. 2. Excessive load on vehicle. 3. Improper mounting of controller. 4. Operation in extreme environments.
4,4	ANTI-TIEDOWN	3	Mode 2 or Mode 4 selected at startup	1. Mode switches shorted to B+. 2. Mode switches “tied down” to select Mode 2 or Mode 4 permanently.

LED DIAGNOSTICS

A Status LED is built into the 1244 controller. It is visible through a window in the label on top of the controller. This Status LED displays fault codes when there is a problem with the controller or with the inputs to the controller. During normal operation, with no faults present, the Status LED flashes steadily on and off. If the controller detects a fault, a 2-digit fault identification code is flashed continuously until the fault is corrected. For example, code “3,2”—welded main contactor—appears as:



The codes are listed in Table 6.

LED CODES		EXPLANATION
<i>LED off</i>		no power or defective controller
<i>solid on</i>		controller or microprocessor fault
		
0,1	 	controller operational; no faults
1,1	 	[not used]
1,2	 	hardware failsafe fault
1,3	 	M-, current sensor, or motor fault
1,4	 	[not used]
2,1	 	throttle fault
2,2	 	static return to off (SRO) fault
2,3	 	high pedal disable (HPD) fault
2,4	 	emergency reverse circuit check fault
3,1	 	contactor driver overcurrent
3,2	 	welded main contactor
3,3	 	precharge fault
3,4	 	missing contactor, or main cont. did not close
4,1	 	low battery voltage
4,2	 	overvoltage
4,3	 	thermal cutback, due to over/under temp.
4,4	 	anti-tiedown fault

Note: Only one fault is indicated at a time, and faults are not queued up. Refer to the troubleshooting chart (Table 5) for suggestions about possible causes of the various faults.

FAULT OUTPUT DRIVERS

The 1244 controller provides two fault output drivers designed for use with a display to provide fault information to the operator. The fault output drivers, Fault 1 (Pin 5) and Fault 2 (Pin 6), are open collector drivers rated at 10 mA maximum current at the nominal battery voltage. They are intended to drive display LEDs but can be used to drive anything that operates within the drivers' limits. These outputs can be configured to display faults in Fault Code format or Fault Category format—see *Section 3, page 42*.

In Fault Code format, the two fault outputs operate independently. The Fault 1 line flashes the same codes, at the same time, as the controller's built-in Status LED (see Table 6). This line can therefore be used to drive an LED located on the display panel in order to provide fault code information directly to the operator. The Fault 2 line pulls to ground (B-) when a fault is present; it can be used to drive a remote LED that simply indicates whether or not there is a fault. When no faults are present, both of the fault lines are in their normal state (high).

In Fault Category format, the two fault outputs together define one of four fault categories, as listed in Table 7. When a fault occurs, the Fault 1 and Fault 2 lines (Pins 5 and 6) go to the state indicating the category of the particular fault: **LOW/HIGH**, **HIGH/LOW**, or **LOW/LOW**. When the fault is cleared, the fault outputs return to their normal state (i.e., **HIGH/HIGH**).

FAULT 1 DRIVER	FAULT 2 DRIVER	FAULT CATEGORY	POSSIBLE FAULT
HIGH	HIGH	0	(no known faults)
LOW	HIGH	1	Hardware failsafe fault M-, current sensor, or motor fault Throttle fault Emergency reverse wiring fault Contactor or output driver fault Precharge fault
HIGH	LOW	2	Low battery voltage Overvoltage Thermal cutback, due to over/under temp
LOW	LOW	3	Static return to off (SRO) fault High pedal disable (HPD) fault Anti-tiedown fault

9

MAINTENANCE

There are no user serviceable parts in the Curtis 1244 controller. **No attempt should be made to open, repair, or otherwise modify the controller.** Doing so may damage the controller and will void the warranty.

It is recommended that the controller be kept **clean and dry** that its diagnostics history file be checked and cleared periodically.

CLEANING

Periodically cleaning the controller exterior will help protect it against corrosion and possible electrical control problems created by dirt, grime, and chemicals that are part of the operating environment and that normally exist in battery powered systems.



When working around any battery powered vehicle, proper safety precautions should be taken. These include, but are not limited to: proper training, wearing eye protection, and avoiding loose clothing and jewelry.

Use the following cleaning procedure for routine maintenance. Never use a high pressure washer to clean the controller.

1. Remove power by disconnecting the battery.
2. Discharge the capacitors in the controller by connecting a load (such as a contactor coil or a horn) across the controller's B+ and B- terminals.
3. Remove any dirt or corrosion from the power and signal connector areas. The controller should be wiped clean with a moist rag. Dry it before reconnecting the battery.
4. Make sure the connections are tight. Refer to Section 2, page 7, for maximum tightening torque specifications for the battery and motor connections.

DIAGNOSTIC HISTORY

The programmer can be used to access the controller's diagnostic history file, via its Diagnostics Menu. The programmer will display all the faults that the controller has experienced since the last time the diagnostic history file was cleared. After a problem has been diagnosed and corrected, it is a good idea to clear the diagnostic history file. This allows the controller to accumulate a new file of faults. By checking the new diagnostic history file at a later date, you can readily determine whether the problem was indeed fixed.

APPENDIX A

GLOSSARY OF FEATURES AND FUNCTIONS

Acceleration rate

The acceleration rate is the time required for the controller to increase from 0 to 100% drive output. The acceleration rate is a MultiMode™ parameter and is programmable from 0.1 to 5.0 seconds—*see Section 3, page 26*.

The accel rate parameter together with the Current Ratio, Quick Start, and Throttle Map parameters allows the OEM to tune the vehicle's performance in response to increased throttle—*see Section 6, page 62*.

Access rights

Each programmable parameter is assigned an access level—OEM or User—that defines who is allowed to change that parameter. These levels are assigned by the OEM when the controller is originally specified. Restricting parameter access to the OEM reduces the likelihood of important performance characteristics being changed by someone unfamiliar with the vehicle's operation. In some cases, it may be necessary to restrict a parameter's access to ensure that it is not set to a value in violation of EEC or other safety regulations. The 1313-1109 User programmer, for example, can adjust only those parameters with User access. The 1313-4409 OEM programmer can adjust all the parameters with User or OEM access rights. Typically, OEMs supply 1313-1109 programmers to their dealers and distributors so that the User-access parameters (for example, the acceleration rate and maximum speed) can be set to each customer's liking, and so that the programmer's testing and diagnostics capabilities can be used.

Anti-tiedown

The anti-tiedown feature is designed to discourage operators from taping or otherwise "tying down" the mode select switches in order to operate permanently in Mode 2 or Mode 4. At startup, when the interlock switch is first closed, the anti-tiedown feature checks which operational mode is selected. If the mode switches are requesting Mode 2 or Mode 4 (Mode Select 1 switch closed), the controller will ignore the request and default to Mode 1 or Mode 3. The controller will remain in Mode 1 or Mode 3 until the Mode Select 1 switch is released and reactivated.

Auxiliary driver

The auxiliary driver is a low side driver capable of pulling a 2 ampere load to B-. This output is overcurrent protected. It is designed to drive a contactor coil, but can be used to drive any load requiring less than 2 amperes.

Braking rate

The braking rate is the time required for the controller to increase from 0 to 100% braking current when braking is requested. The braking rate is a MultiMode™ parameter and is programmable from 0.1 to 5.0 seconds—see *Section 3, page 26*.

CAN Bus

CAN (Controller Area Network) Bus provides a two-wire communications system for electric vehicles. It is widely used in automotive applications and is also well suited to electrically controlled material handling systems. Use of the CAN Bus system considerably reduces the complexity of the vehicle's wire harness. Additionally, the CAN Bus communications protocol provides error and fault detection to ensure proper signal and command transmission and reception. The CAN Bus system carries a high level of immunity to electromagnetic interference, as well. For information regarding the CAN-Nodes protocol that Curtis uses in its controllers, refer to the Curtis CAN Protocol Document—available from local Curtis offices.

Control mode

The control mode parameter determines whether throttle position controls applied current (Type 0) or applied voltage (Type 1). Selection is made with the programmer—see *Section 3, page 28*.

Creep speed

Creep speed is activated when a direction is first selected. The output maintains creep speed until the throttle is rotated out of the throttle deadband (typically 10% of throttle). Creep speed is a MultiMode™ parameter and is programmable from 0 to 25% of the PWM duty cycle—see *Section 3, page 27*.

Current limiting

Curtis controllers limit the motor current to a preset maximum. This feature protects the controller from damage that might result if the current were limited only by motor demand. PWM output to the armature and field power sections is reduced until the motor current falls below the set limit level.

In addition to protecting the controller, the current limit feature also provides some protection to the rest of the system. By eliminating high current surges during vehicle acceleration, stress on the motor and batteries is reduced and their efficiency enhanced. Similarly, there is less wear and tear on the vehicle drivetrain, as well as on the ground on which the vehicle rides.

The drive and braking current limits are programmable independently in each of the four modes—see *Section 3, page 36*.

Current ratio

The 1244 controller's current limit increases with increased throttle, according to an algorithm developed to produce smooth starts and good overall vehicle driving characteristics. The current ratio parameter allows the OEM to adjust the amount of current available at low throttle requests in order to provide quicker startups and improved ramp climbing at partial throttle if that is desired for a specific application. Refer to Section 3, page 38, for the range of programmable settings, and to Section 6 for instructions on how to use this parameter to tune vehicle performance.

Decel rate

The deceleration rate defines the time the controller takes to reduce its PWM output to zero when the throttle request is reduced from 100% to zero. The decel rate is programmable from 0 to 10 seconds—*see Section 3, page 26.*

The decel rate parameter together with the Restraint and Throttle Braking Percent parameters allows the OEM to tune the vehicle's performance in response to reduced throttle, especially when traveling downhill—*see Section 6, page 63.*

Emergency reverse

Emergency reverse is activated when the keyswitch is On and the emergency reverse input is pulled high, provided the controller is configured with this feature active. Typically, 1244 controllers are used on rider vehicles. Emergency reverse is only applicable to walkies. If you plan to install your 1244 controller on a walkie, refer to Section 2, page 19, and to Section 3, page 48, for instructions regarding emergency reverse.

Environmental protection

The 1244 controller is housed in a rugged ABS plastic case providing environmental protection that meets the requirements of IP64/IP67. The controller should be kept clean and dry to ensure long life. Additional protection is recommended if the controller is mounted in a location exposed to dirt or water splash.

ET-series electronic throttles

The ET-XXX is a wigwag-style throttle control assembly. It provides a 0–5V signal in both the forward and reverse directions. Use of this throttle control assembly requires that the controller's throttle input be configured for a Type 2 (single-ended 0–5V) throttle.

Fault categories

The 1244 controller is equipped with two fault drivers. These drivers can be configured to provide information in “fault category” or “fault code” format. If the drivers are configured in “fault category” format, they will indicate one of three categories of faults. The Fault Categories are defined in Table 7—*see Section 8, page 75*.

Fault codes

The 1244 controller provides fault information by flashing Fault Codes. When a fault occurs, the fault code can be read directly from the Status LED built into the controller’s cover. In addition, the controller has two output drivers that can be configured to provide information in “fault category” or “fault code” format. If the drivers are configured in “fault code” format, they will drive fault indicator LEDs located on a remote panel. The information displayed by these remote panel LEDs will be identical to that displayed by the controller’s built-in Status LED. The Fault Codes are defined in Table 6—*see Section 8, page 74*.

Fault detection and response

An internal microcontroller automatically maintains surveillance over the functioning of the controller. When a fault is detected, the appropriate fault code is signalled via the controller’s built-in Status LED, which is externally visible through the label on top of the controller. If the fault is critical, the controller is disabled. More typically, the fault is a remediable condition and temporary—for example, an HPD fault is cleared when the throttle is returned to neutral. The faults covered by the 1244 controller’s automatic fault detection system are listed in Table 5—*see Section 8, page 73*.

Fault recording

Fault events are recorded in the controller’s diagnostic history file. Multiple occurrences of the same fault are recorded as one occurrence. This fault event list can be loaded into the programmer for readout. The programmer’s Diagnostics Menu provides access to the controller’s diagnostic history file—the entire fault event list created since the diagnostic history file was last cleared. The Diagnostics Menu also provides information about the currently active faults.

Fault recovery (including recovery from disable)

Almost all faults require a cycling of the keyswitch or interlock switch to reset the controller and enable operation. The only exceptions are these:

FAULT	RECOVERY
anti-tiedown	when Mode Select 1 switch is released
contactor overcurrent	when condition clears
HPD	when throttle is lowered below HPD threshold
overvoltage	when battery voltage drops below overvoltage
SRO	when proper sequence is followed
thermal cutback	when temperature returns to acceptable level
throttle faults	when condition clears
undervoltage	when battery voltage rises above undervoltage
<i>(all other faults)</i>	<i>(cycle keyswitch or interlock switch)</i>

Field map

The field map parameter determines the relationship between the shunt field winding current and the armature current. The field map parameter affects vehicle acceleration and midrange torque characteristics. This parameter is programmable—see *Section 3, page 39*.

Field map and the other field current parameters (field map start, field max, field min) allow the OEM to tune the vehicle's performance characteristics—see *Section 6, pages 57–61*.

Field map start

The field map start parameter defines the armature current at which the field map starts to increase. The field map start parameter is used to help equalize the vehicle's maximum speed when loaded and unloaded. This parameter is programmable—see *Section 3, page 38*.

Field map start and the other field current parameters (field map, field max, field min) allow the OEM to tune the vehicle's performance characteristics—see *Section 6, pages 57–61*.

Full bridge

The 1244 controller uses a full bridge design for control of the field winding. This eliminates the need for external direction contactors. The result is a higher reliability product that is smaller and simpler to install.

Half bridge

The 1244 controller uses a half bridge topology for the armature drive. This provides reliable and highly efficient vehicle control with full all-electronic regenerative braking to zero speed.

High-pedal-disable (HPD)

The HPD feature prevents the vehicle from driving the motor if the controller is turned on when greater than HPD threshold throttle is applied. Three types of HPD are available (along with a “no HPD” option). Selection is made with the programmer—see *Section 3, page 41*.

Interlock switch

This switch is a controller-enable input intended to provide a secondary operational interlock for the controller in addition to the keyswitch input. If an interlock switch is used, it must be closed—providing a high signal to the interlock pin (Pin 2)—in order for the controller to operate. This safety interlock is used on most material handling vehicles. Cycling the interlock switch or the keyswitch clears most faults and re-enables operation.

KSI

KSI (Key Switch Input) provides power to the controller’s logic board, initializes the microprocessor, and starts diagnostics. In combination with the interlock switch input, KSI enables all logic functions.

Load compensation

The load compensation feature automatically adjusts the applied motor voltage as a function of motor load current. This results in more constant vehicle speeds over variations in motor loading due to ramps and cargo weights—without the operator having to constantly adjust the throttle position. The load compensation parameter is programmable—see *Section 3, page 49*.

The load compensation and Field Map Start parameters allow the OEM to tune the vehicle’s loaded top speed to approach its unloaded top speed—see *Section 6, pages 60–61*.

M- fault detect

This feature determines if the M- power connection is being held low (to B-) by an internal or external fault condition. If an M- fault is detected, the controller will inhibit PWM output and release the main and auxiliary contactors. M-fault detection is not performed if greater than 85% throttle is being requested or if emergency reverse is activated.

MOSFET

A MOSFET (metal oxide semiconductor field effect transistor) is a type of transistor characterized by its fast switching speeds and very low losses.

MultiMode™

The MultiMode™ feature of the 1244 controller allows the vehicle to be operated with four distinct sets of characteristics. The four modes can be programmed to be suitable for operation under different conditions, such as slow precise indoor maneuvering in one mode; faster, long distance, outdoor travel in another mode; and application-specific special conditions in the remaining two modes. For more information about MultiMode™ operation, refer to Section 3.

OEM (= Original Equipment Manufacturer)**Overtemperature**

Because of their efficiency and thermal design, Curtis controllers should barely get warm in normal operation. Overheating can occur, however, if the controller is undersized for its application or otherwise overloaded. The 1244 controller constantly monitors its internal heatsink temperature. Starting at 85°C, the drive and braking current limits are linearly decreased from full set current down to zero at 95°C.

Full current limit and performance return automatically after the controller cools down. Although occasional overtemperature operation is usually not damaging to the controller, it does suggest a mismatch. If thermal cutback occurs often in normal vehicle operation, the controller is probably undersized for the application and a higher current model should be used. Continuous operation in overtemperature will overstress the power components and reduce the lifetime and reliability of the controller.

Overvoltage cutoff

The overvoltage protection feature inhibits the PWM and shuts down the controller, if the voltage exceeds the factory-set limit. Overvoltage can result during battery charging or from an improperly wired controller. Controller operation resumes when the voltage is brought within the acceptable range. The cutoff voltage and re-enable voltage are percentages of the battery voltage, and are defined by the Battery Voltage parameter setting—see *Section 3, page 46*.

Plug braking

The 1244 controller uses plug braking as well as regen braking to apply braking torque to the vehicle's motor. Plug braking takes place when braking is requested and the vehicle speed is less than the programmed regen speed. During plug braking, the current is limited to the drive current limit.

PWM

Pulse width modulation (PWM), also called “chopping,” is a technique that switches battery voltage to the motor on and off very quickly, thereby controlling the speed of the motor. Curtis 1200 series controllers use high frequency PWM—in this case, 16 kHz—which permits silent, efficient operation.

Quick-start

Upon receiving a quick throttle demand from neutral, the controller will momentarily exceed normal acceleration in order to overcome inertia. The “quick-start” algorithm is applied each time the vehicle passes through neutral and is not in braking mode. If the vehicle is braking, the quick-start function is disabled, allowing normal braking to occur. The quick-start parameter is programmable—see *Section 3, page 26*.

Regenerative braking

Regenerative braking occurs when current generated by the motor during braking is allowed to flow back into the batteries. Regen braking results in less motor heating and reduced brush wear compared with plug braking. Regen braking also provides some return of energy to the battery pack, allowing longer vehicle operating periods.

The braking rate defines the time it takes the controller to increase from 0% to 100% regen braking current when braking is requested. The braking rate is a MultiMode™ parameter and is programmable from 0.1 to 5.0 seconds—see *Section 3, page 26*.

The regen speed parameter defines the threshold vehicle speed above which the controller initiates regen braking. Below this speed, plug braking is used. The regen speed is programmable from 0 to 100% of the vehicle speed—see *Section 3, page 27*.

Restraint

When the vehicle speed exceeds the requested throttle, the restraint feature causes the motor to apply a braking force and “restrain” the vehicle to the requested speed. The restraint parameter defines the amount of braking current the controller allows in the motor when it attempts to prevent the vehicle from overspeed—see *Section 3, page 37*.

The restraint parameter together with the Decel Rate and Throttle Braking Percent parameters allows the OEM to tune the vehicle’s performance in response to reduced throttle, especially when traveling downhill—see *Section 6, page 63*.

The restraint parameter also can be used to limit the vehicle’s rate of downhill creeping when it is stopped on an incline and the brake has not engaged—see *Section 6, page 66*.

Reverse polarity protection

Reverse voltage will damage the controller. Reverse polarity protection is provided by including a diode in series with the control line as shown in the standard wiring diagram, Figure 3. When this diode is used, reversing the battery's B+ and B- connections to an otherwise properly wired controller will not allow the main contactor to be engaged. This protects the controller from being damaged by the reverse polarity.

Safe commutation region

The safe commutation region includes all the combinations of field current and armature current that allow proper commutation between the motor's brushes and the armature. If the motor operates outside this region, arcing and severe heating and brush wear will occur. The motor manufacturer should be able to provide curves defining the safe combinations of field and armature current. We highly recommend that you obtain these curves and use them when tuning the 1244 controller to a particular motor.

Sequencing delay

Sequencing delay allows the interlock switch to be momentarily opened within a set time (the sequencing delay), thus preventing inadvertent activation of HPD or SRO. This feature is useful in applications where the interlock switch may bounce or be momentarily cycled during operation. The sequencing delay is programmable from 0 to 3 seconds, with 0 corresponding to no delay—*see Section 3, page 47.*

Speed limiting

The maximum speed can be limited in each of the four modes. This is done in two ways: through the maximum speed parameter (*see Section 3, page 27*) and through the minimum field current limit parameter (*see Section 3, page 36*). The latter (the Min Field parameter) is the primary means of adjusting vehicle top speed. Guidelines for adjusting maximum speed are presented in Section 6: Vehicle Performance Adjustment.

Static-return-to-off (SRO)

The SRO feature prevents the vehicle from being started when “in gear” (i.e., with a direction already selected). Three types of SRO are available (along with a “no SRO” option). Selection is made with the programmer—*see Section 3, page 42.*

Status LED

A Status LED (Light Emitting Diode) is built into the controller. It is visible through the label located on top of the controller. The Status LED flashes a 2-digit fault identification code when a fault is detected by the controller. The fault code continues to flash until the fault has been corrected and the fault condition has been cleared. Clearing the fault condition typically requires cycling KSI for faults detected during startup, and cycling the interlock switch for faults detected during operation. The fault codes are defined in Table 6—*see Section 8, page 74*.

Taper rate

The taper rate defines how gradually the vehicle slows down at the completion of regen braking. The taper rate is programmable—*see Section 3, page 27*.

Temperature compensation for current limits

Full temperature compensation provides constant current limits throughout the normal operating range (heatsink temperatures of -25°C to $+85^{\circ}\text{C}$). The temperature sensor that regulates the current limits is also used to calculate the heatsink temperature displayed by the programmer.

Throttle braking

The throttle braking feature provides automatic braking when the controller's throttle input is reduced. The strength of braking is determined by the programmed Throttle Braking Percent parameter value. Throttle braking can be disabled (i.e., set to 0%) if this feature is not desired. Throttle Braking Percent is a MultiMode™ parameter—*see Section 3, page 36*.

The Throttle Braking Percent parameter together with the Decel Rate and Restraint parameters allows the OEM to tune the vehicle's performance in response to reduced throttle, especially when traveling downhill—*see Section 6, page 63*.

Throttle deadband (neutral deadband)

The throttle deadband is the pot wiper voltage range that the controller interprets as neutral. The throttle deadband is typically set at 10%. A higher setting increases the neutral range, which can be useful with throttle assemblies that do not return reliably to a well-defined neutral point. The throttle deadband parameter is programmable—*see Section 3, pages 30–31, and Section 6, page 55*.

Throttle map

The throttle map parameter determines the controller's static throttle map, adjusting the throttle characteristics to suit your specific application and enhance your vehicle's performance. The throttle map parameter modifies the controller's PWM output relative to the requested throttle amount. The throttle map is a MultiMode™ parameter—see *Section 3, page 34*.

Throttle max

The throttle max parameter allows accommodation of throttles that do not provide the standard full range of voltage or resistance variation at the throttle input. Reducing the throttle max parameter value allows full controller output with a throttle input less than that specified in Table 1 (page 10). The throttle max parameter can be programmed to fit your specific vehicle's requirements—see *Section 3, pages 32–33, and Section 6, page 56*.

Throttle types

The 1244 controller accepts a variety of throttle inputs, through various combinations of its three throttle input pins. The most commonly used single-ended and wigwag throttles (5k Ω –0 and 0–5k Ω pots, 3-wire pots, 0-5V throttles, and the Curtis ET-XXX electronic throttle) can be used simply by selecting the appropriate throttle type in the programmer's Program Menu—see *Section 3, page 29*. The controller can also be specified to receive throttle signals from a CAN-based communications system—see *Section 4, page 51*.

Tuning

The 1244 controller provides a variety of programmable parameters to assist in tuning the vehicle to meet the customer's needs. Section 6: Vehicle Performance Adjustment presents information and procedures for tuning specific operating characteristics on any vehicle.

Undertemperature

When the controller is operating at less than -25°C, the drive current limit is cut back to approximately one-half its rated value. The controller will warm itself at this reduced current and when its internal temperature rises above -25°C, full current will become available.

Undervoltage protection

Undervoltage protection automatically cuts back the controller output if battery voltage is detected below the undervoltage point at startup, or when the battery voltage is pulled below the undervoltage point by an external load. The undervoltage cutback point is determined by the battery voltage parameter, which should be identical to the system's nominal battery pack voltage—*see Section 3, page 46.*

During normal operation, the controller duty cycle will be reduced when the batteries discharge down to less than the undervoltage level. If the motor current is such that the batteries are being pulled below the minimum point, the duty cycle will be reduced until the battery voltage recovers to the minimum level. In this way the controller “servos” the duty cycle around the point which maintains the minimum allowed battery voltage.

If the voltage continues to drop below the undervoltage level to a severe undervoltage condition (due to battery drain or external load), the controller continues to behave in a predictable fashion, with its output disabled.

Watchdog (external, internal)

The external watchdog timer guards against a complete failure of the microprocessor, which would incapacitate the internal watchdog timer. This independent system check on the microprocessor meets the EEC's requirement for backup fault detection.

The external watchdog timer safety circuit shuts down the controller (and the microprocessor) if the software fails to generate a periodic external pulse train. This pulse train can only be created if the microprocessor is operating. If not periodically reset, the watchdog timer times out after 15–20 msec and turns off the controller. The external watchdog also directly shuts down the PWM drive to the MOSFETs. It can only be reset by cycling KSI.

The internal watchdog timer must be reset periodically by correct sequential execution of the software. If not reset, the internal timer times out and the microprocessor is “warm booted.” This causes the microprocessor to shut down its outputs—thus shutting down the controller—and attempt to restart.

Welded contactor checks

The 1244 controller checks for a welded main contactor at startup. If a welded contactor is detected, the controller inhibits its output until the fault is removed and the keyswitch power is cycled. A welded main contactor fault is indicated in the programmer's Diagnostics Menu as well as by the controller's Status LED.

APPENDIX B

PROGRAMMING DEVICES

Curtis programmers provide programming, diagnostic, and test capabilities for the 1244 controller. The power for operating the programmer is supplied by the host controller via a 4-pin connector. When the programmer powers up, it gathers information from the controller.

Two types of programming devices are available: the 1314 PC Programming Station and the 1313 handheld programmer. The Programming Station has the advantage of a large, easily read screen; on the other hand, the handheld programmer (with its 45×60mm screen) has the advantage of being more portable and hence convenient for making adjustments in the field.

Both programmers are available in User, Service, Dealer, and OEM versions. Each programmer can perform the actions available at its own level and the levels below that—a User-access programmer can operate at only the User level, whereas an OEM programmer has full access.

PC PROGRAMMING STATION (1314)

The Programming Station is an MS-Windows 32-bit application that runs on a standard Windows PC. Instructions for using the Programming Station are included with the software.

HANDHELD PROGRAMMER (1313)

The 1313 handheld programmer is functionally equivalent to the PC Programming Station; operating instructions are provided in the 1313 manual. This programmer replaces the 1307 and 1311, earlier models with fewer functions.

PROGRAMMER FUNCTIONS

Programmer functions include:

Parameter adjustment — provides access to the individual programmable parameters.

Monitoring — presents real-time values during vehicle operation; these include all inputs and outputs.

Diagnostics and troubleshooting — presents diagnostic information, and also a means to clear the fault history file.

Programming — allows you to save/restore custom parameter settings files and also to update the system software (not available on the 1307 or 1311).

Favorites — allows you to create shortcuts to your frequently-used adjustable parameters and monitor variables (not available on the 1307 or 1311).

APPENDIX C SPECIFICATIONS

Table C-1 SPECIFICATIONS: 1244 CONTROLLER

Nominal input voltage	24–36V, 36–48V, and 48–80V
PWM operating frequency	16 kHz
Electrical isolation to heatsink	500 V ac (minimum)
KSI input voltage (minimum)	16.8 V for 24–36 V systems
KSI input current (no contactors engaged)	160 mA without programmer; 200 mA with programmer
Logic input voltage	>7.5 V High; <1 V Low
Logic input current	10 mA
Operating ambient temperature range	-40°C to 50°C (-40°F to 122°F)
Heatsink overtemperature cutback	85°C (185°F)
Heatsink undertemperature cutback	-25°C (-13°F)
Package environmental rating	IP64 / IP67
Weight	3.9 kg (8.5 lb)
Dimensions (LxWxH)	229 x 178 x 81 mm (9.0" x 7.0" x 3.2")

MODEL NUMBER	NOMINAL BATTERY VOLTAGE (volts)	ARMATURE CURRENT LIMIT (amps)	ARMATURE 2 MIN RATING (amps)	ARMATURE 1 HOUR RATING * (amps)	FIELD 2 MIN RATING (amps)
1244-44XX	24–36	400	400	160	60
1244-45XX	24–36	500	500	175	60
1244-46XX	24–36	600	600	190	60
1244-47XX	24–36	700	700 †	190	60
1244-54XX	36–48	400	400	140	50
1244-55XX	36–48	500	500	160	50
1244-56XX	36–48	600	600	160	50
1244-64XX	48–80	400	400	125	50
1244-65XX	48–80	500	500	140	50
1244-66XX	48–80	600	600 †	140	50

* at 25°C ambient temperature

† 1-minute rating